

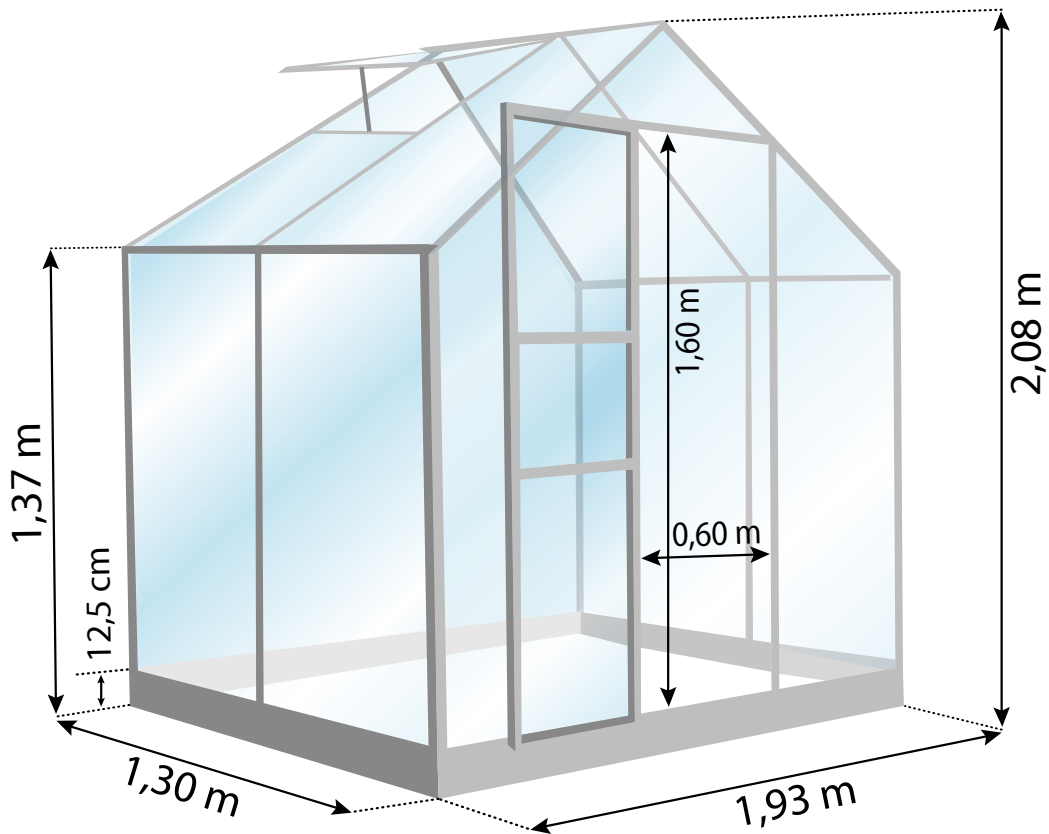

LAMS



SERRE - GEWÄCHSHAUS - GREENHOUSE

ALLIUM 2,50 M²



NOTICE DE MONTAGE

IMPORTANT

- **Pensez à déclarer votre serre de jardin à votre assureur.**
- Merci de lire ces instructions attentivement avant de commencer le montage de la serre.
- Merci de vous assurer que toutes les pièces mentionnées sur cette notice sont présentes dans le carton et de vérifier les quantités.
- Merci de suivre les étapes dans l'ordre indiqué par la notice.
- Veuillez conserver soigneusement ce manuel de montage pour une consultation ultérieure.

CONSEILS DE SÉCURITÉ

- Veuillez porter gants, chaussures et lunettes de protection pour le montage de la serre.
- Respectez les conseils de sécurité des outils que vous utilisez pour ce montage.
- En cas d'intempéries (pluie, vent, orage...), ne montez pas votre serre.
- La serre doit être montée par 2 personnes.
- Les sachets plastiques et les petits composants sont à tenir hors de portée des enfants. Eloignez les enfants de la zone de montage.
- L'aluminium est un métal conducteur d'électricité, tenez les profilés aluminium éloignés de toute source électrique.
- Tout appareil produisant de la chaleur ne doit pas être stocké dans la serre (barbecue, chalumeau, ...).
- La serre doit être positionnée et fixée sur un sol horizontal et plan, non exposé au vent.
- Vérifiez l'absence de réseaux (eau, électricité, gaz) sous l'emplacement de montage de la serre.
- Attention, ne pas monter sur le toit : risque de chute et de blessures graves.
- En cas de forte chute de neige ne pas laisser la neige s'accumuler sur le toit.

CONSEILS D'ENTRETIEN

- Pour nettoyer votre serre, utilisez de l'eau claire savonneuse.
- N'utilisez surtout pas d'acétone, des nettoyants abrasifs ou autres détergents spéciaux pour nettoyer les panneaux.
- Graissez régulièrement le rail de porte.
- Dégagez le toit de la neige et des feuilles.

SERVICE CLIENTS

Site internet : www.sav-doviris.com



MONTAGEANLEITUNG

WICHTIG

- **Denken Sie daran, Ihr Gewächshaus bei Ihrer Versicherung anzumelden.**
- Bitte lesen Sie diese Anleitung sorgfältig durch, bevor Sie mit der Montage beginnen.
- Bitte stellen Sie sicher, dass alle in dieser Anleitung aufgeführten Einzelteile im Karton vorhanden sind und prüfen Sie die Mengen.
- Bitte folgen Sie den Schritten in der im Handbuch angegebenen Reihenfolge.
- Bewahren Sie diese Anleitung für späteres Nachschlagen sorgfältig auf.

SICHERHEITSHINWEISE

- Bitte tragen Sie bei der Montage des Gewächshauses Handschuhe, Schuhe und Schutzbrille.
- Beachten Sie die Sicherheitshinweise der Werkzeuge, die Sie für diese Montage verwenden.
- Stellen Sie Ihr Gewächshaus nicht bei schlechtem Wetter (Regen, Wind, Gewitter . . .) auf.
- Das Gewächshaus muss von 2 Personen zusammengebaut werden.
- Die Plastiktüten und Kleinteile sollten außerhalb der Reichweite von Kindern aufbewahrt werden. Halten Sie die Kinder vom Montagebereich fern.
- Aluminium ist ein elektrisch leitfähiges Metall, halten Sie die Aluminiumprofile von allen elektrischen Quellen fern.
- Wärmeerzeugenden Geräte (Grill, Brenner, . . .) dürfen im Gewächshaus nicht gelagert werden.
- Das Gewächshaus muss auf einem horizontalen und ebenen, nicht dem Wind ausgesetzten Boden aufgestellt und befestigt werden.
- Stellen Sie sicher, dass es keine Netze (Wasser, Strom oder Gas) unter dem Installationsort gibt.
- Achtung, nicht auf das Dach steigen: Sturz- und schwere Verletzungsgefahr.
- Bei starkem Schneefall den Schnee nicht auf dem Dach ansammeln lassen.

PFLEGEHINWEISE

- Verwenden Sie zur Reinigung Ihres Gewächshauses klares Seifenwasser.
- Verwenden Sie kein Aceton, Scheuermittel oder andere Reinigungsmittel zum Reinigen der Platten.
- Regelmäßig die Türschiene schmieren.
- Räumen Sie das Dach frei von Schnee und Laub.

KUNDENSERVICE

kontakt@gewaechshaus-lams.com



ASSEMBLY INSTRUCTIONS

IMPORTANT

- **Remember to declare your greenhouse to your insurer.**
- Please read these instructions carefully before starting to assemble the greenhouse.
- Please ensure that all the components mentioned in this instruction are present in the box and check the quantities.
- Please follow the steps in the order indicated by the manual.
- Please keep this assembly instruction in a safe place for future reference.

SAFETY WARNINGS

- Please wear gloves, shoes and safety goggles when assembling the greenhouse.
- Follow the safety instructions of the tools you use for this assembly.
- In case of bad weather (rain, wind, thunderstorm, ...), do not set up your greenhouse.
- The greenhouse must be assembled by 2 people.
- Plastic bags and small components should be kept out of reach of children. Keep children away from the assembling area.
- Aluminium is a metal with electrical conductivity, keep aluminium profiles away from any electrical source.
- Not all heat-producing appliances (barbecue, torch, ...) can be stored in the greenhouse.
- The greenhouse must be positioned and fixed on a horizontal and even ground, not exposed to wind.
- Check the absence of networks (water, electricity, gas) underneath the installation site of the greenhouse.
- Beware, do not climb on the roof: risk of fall and serious injuries.
- In case of heavy snowfall, do not allow snow to accumulate on the roof.

MAINTENANCE TIPS

- To clean your greenhouse, use clear soapy water.
- Do not use acetone, abrasive cleaners or other special detergents to clean the panels.
- Grease the door rail regularly.
- Clear the roof of snow and leaves.

CUSTOMER SERVICE

Website : www.sav-doviris.com

SERRE - GEWÄCHSHAUS - GREENHOUSE
ALLIUM 2,50 M²

RÉFÉRENCES - ARTIKELNUMMERN - CODES :

















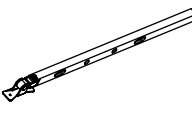
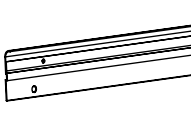
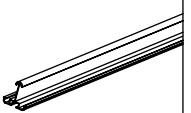

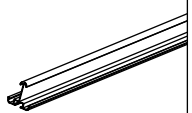

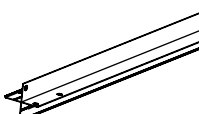
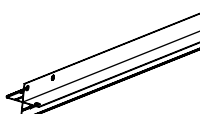
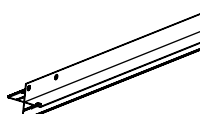
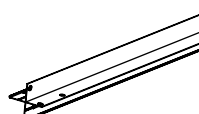
- **ALUMINIUM : 788680**
- **RAL 6009 : 788685**
- **RAL 7016 : 795273**

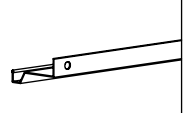
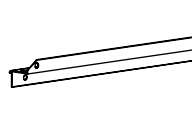
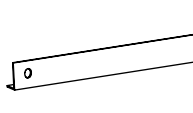
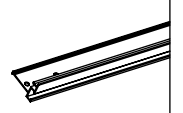



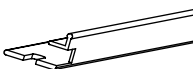



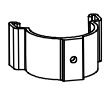

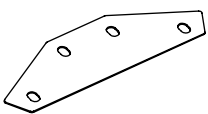
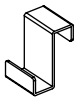

NUMÉRO DE TRAÇABILITÉ - RÜCKVERFOLGBARKEITSNUMMER - TRACEABILITY NUMBER
2024.10

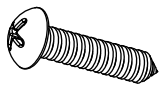
NOMENCLATURE - STÜCKLISTE - BILL OF MATERIALS

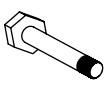

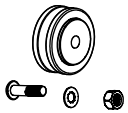

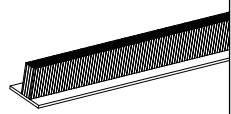

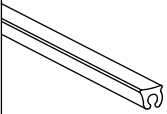
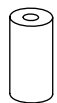

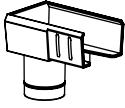

Colis - Paket - Parcel

1/2

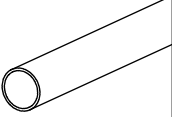
PROFILÉS ALUMINIUM - ALUMINIUMPROFILE - ALUMINIUM PROFILES					
01014 x 2  L:1239mm	01003 x 1  L:1862mm	08002 x 8  L:1302mm	08004 x 1  L:1854mm	08005 x 2  L:600mm	10001 x 1  L:1257mm
15001 x 1  L:270mm	18001 x 1  L:612mm	25001 x 2  L:1133mm	25002 x 2  L:1214mm	25003 x 1  L:1666.5mm	25004 x 1  L:1666.5mm
27001 x 4  L:1214mm	27026 x 1  L:1156mm	27027 x 1  L:1156mm	27028 x 1  L:1156mm	27029 x 1  L:1156mm	29001 x 1  L:1650mm
29002 x 1  L:1650mm	30001 x 1  L:1862mm	32001 x 1  L:628mm	33001 x 1  L:393mm	34001 x 2  L:1612mm	35001 x 1  L:621mm
36001 x 1  L:621mm	37001 x 2  L:621mm	38005 x 1  L:1239mm	39001 x 1  L:634mm	40001 x 1  L:602mm	41001 x 2  L:518mm
42001 x 1  L:602mm	43009 x 2  L:1239mm	58001 x 4 			

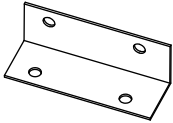
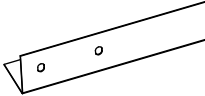

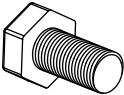



PETITS COMPOSANTS - KLEINTEILE - SMALL COMPONENTS					
W001 x 4 	W006 x 36 	W007 x 140 	1001 x 84  M6	1002 x 70  M6 x 12 mm	1003 x 11  M6 x 8 mm
1004 x 16  M3.5 x 16mm	1005 x 10  M3.5 x 6 mm	1006 x 1  M6 x 35 mm	1015 x 2  Ø 6	1012 x 2  M6 x 5 mm	2001 x 2 
2002 x 2 	2003 x 2 	2004 x 1 	2005 x 2 	2006 x 42m 	2009 x 1 



NOMENCLATURE - STÜCKLISTE - BILL OF MATERIALS

2010 x 2 	2022 x 2 	2023 x 2 	2028 x 2 	2032 x 2 	2041 x 2  L: 1120 mm
BASE ET VISSERIE - FUNDAMENTRAHMEN UND SCHRAUBEN - GREENHOUSE BASE AND SCREWS					
D001 x 2  1922 x 125 x 30 mm	D021 x 2  1300 x 125 x 30 mm	D004 x 4 	D005 x 4 	W008 x 14 	1008 x 16 
1009 x 16  M6 x 12 mm	1010 x 16  M6				

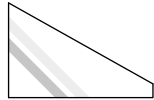
Colis - Paket - Parcel

2/2

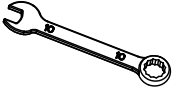
VERRES - GLÄSER - GLAZING						
1 x 24  610 x 610 mm	2 x 3  610 x 544 mm	3 x 1  610 x 467 mm	4 x 1  610 x 229mm	5 x 1  600 x 544 mm	6 x 4  610 x 464/38 mm	7 x 2  610 x 20/234/20 mm

OUTILS INCLUS VORHANDENES WERKZEUG TOOLS INCLUDED		NON INCLUS NICHT VORHANDEN NOT INCLUDED	
 M6/10 mm	 M6/10 mm		 5 m

MONTAGE BASE - MONTAGE FUNDAMENTRAHMEN - BASE ASSEMBLING

Il est impératif que la base soit montée de niveau.



Es ist zwingend erforderlich, dass der Fundamentrahmen auf einem ebenen Untergrund montiert wird.

It is imperative that the greenhouse base is leveled.

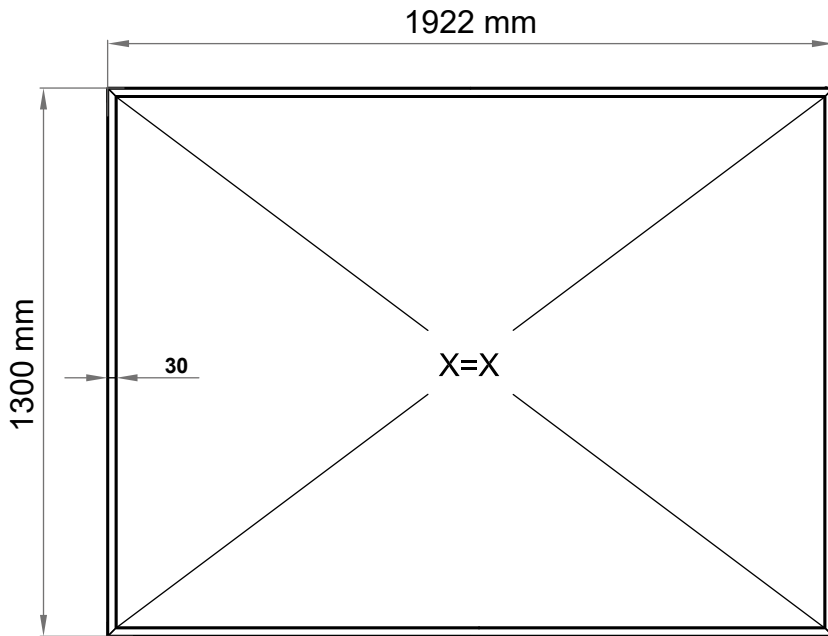

Module de base Basismodul Basic module

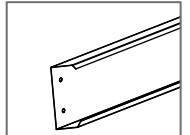

D001 x 2

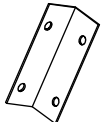

D004 x 4

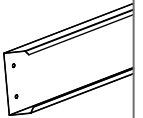

D021 x 2

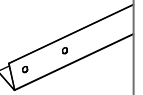

D005 x 4



W008 x 14



1008 x 16



1009 x 16



1010 x 16



Plots béton / Punktfundament / Point foundation : D004 + D005.

Dalle ou pourtour béton / Streifenfundament / Concrete slab or frame : D004.

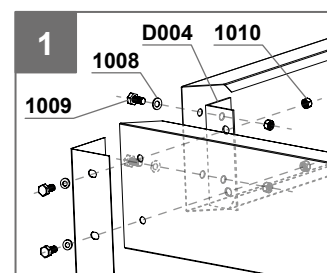
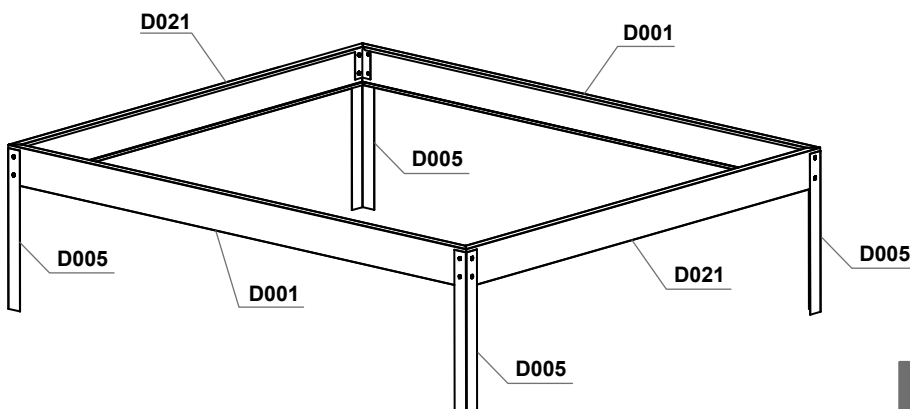

FIXATION DE LA BASE AU SOL

FIXATION EN PLEINE TERRE

- Positionner la base à l'endroit voulu, de niveau sur un sol damé.
- Repérer l'emplacement des pattes de scellement suivant le schéma ci-dessous.
- Marquer un carré de 300 x 300 mm autour des pattes de scellement et creuser sur une profondeur de 450 mm.
- Placer la base, la mettre de niveau et remplir les trous de béton.

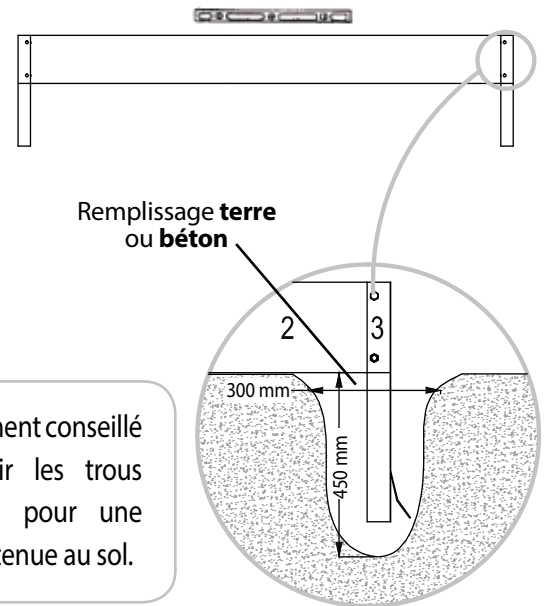
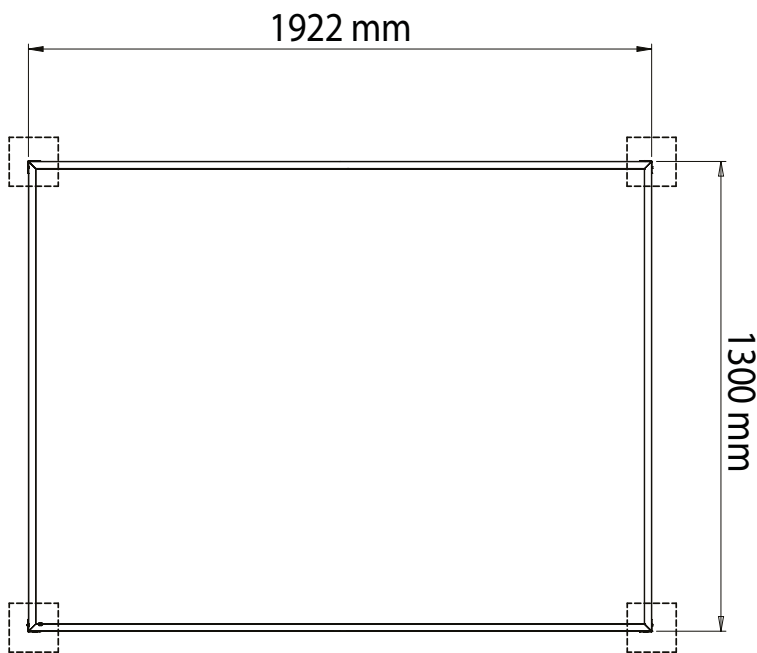

Il est vivement conseillé de remplir les trous de béton pour une meilleure tenue au sol.

OU

FIXATION SUR DALLE BÉTON

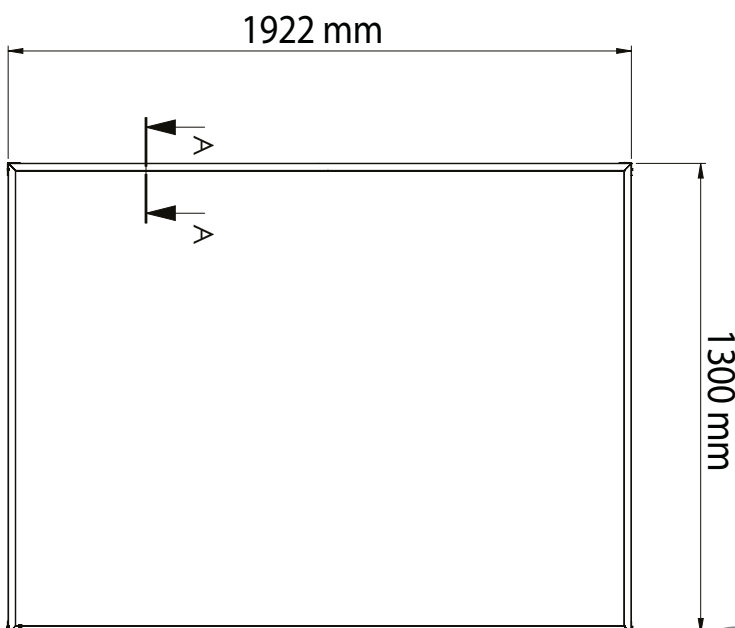

Détail A-A

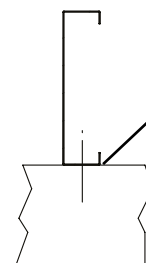

Fixation par chevilles à l'intérieur de la base



Visseries et chevilles de fixation non fournies

Il est laissé à votre libre choix et décision, l'utilisation des fixations adéquats selon les supports que vous décidez d'utiliser (pourtour bois, parpaings, plaques ciment, ...).



BEFESTIGUNG DES FUNDAMENTRAHMENS AM BODEN

BEFESTIGUNG AUF ERDBODEN (Punktfundament)

- Stellen Sie den Fundamentrahmen an der gewünschten Stelle, auf einem ebenen Boden.
- Finden Sie die Stelle der Ankerbeine gemäß dem untenstehenden Schema.
- Markieren Sie ein 300 x 300 mm Quadrat um die Ankerbeine herum und graben Sie 450 mm tief.
- Den Fundamentrahmen platzieren, nivellieren und die Löcher mit Beton füllen.

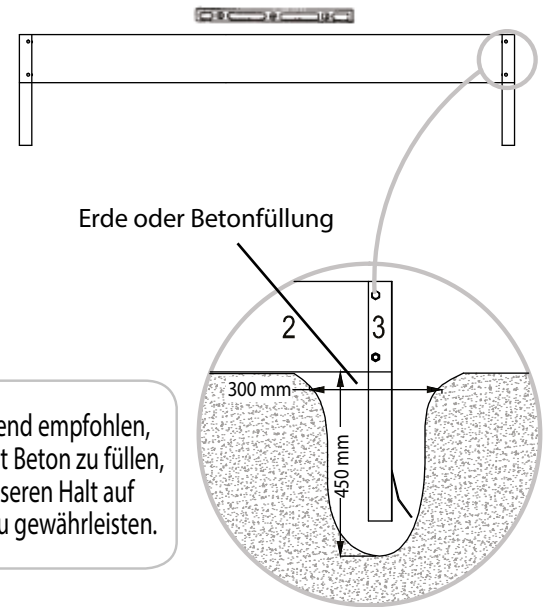
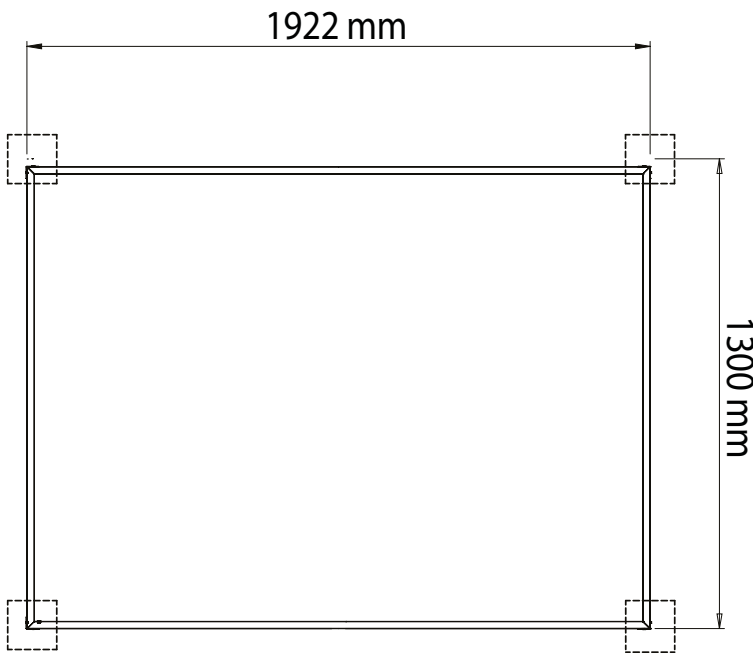

Es wird dringend empfohlen, die Löcher mit Beton zu füllen, um einen besseren Halt auf dem Boden zu gewährleisten.

ODER

BEFESTIGUNG AUF BETONDECKE (Streifenfundament)

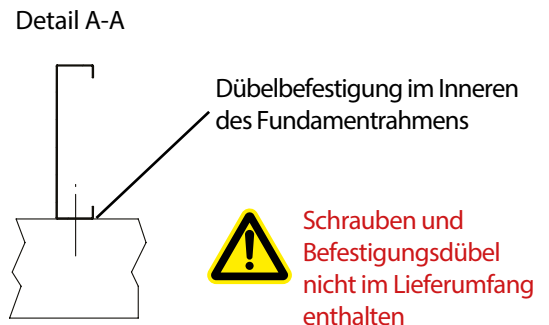
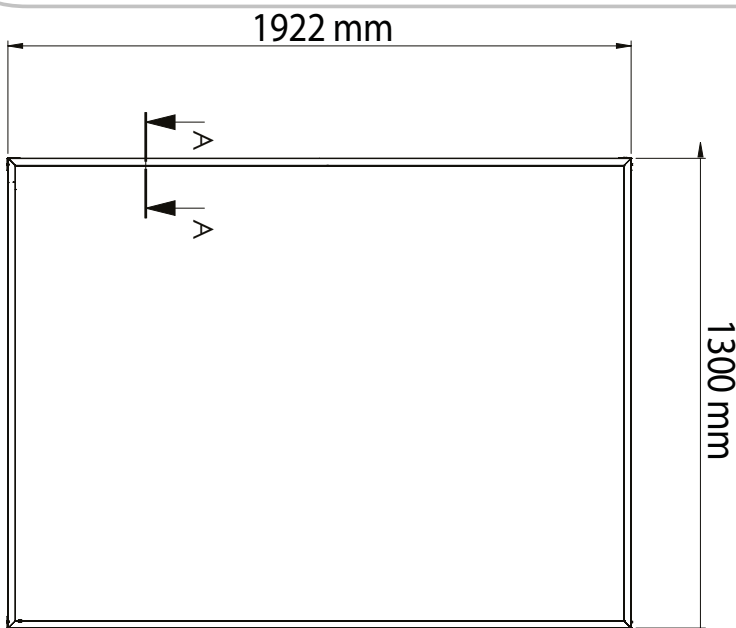

Es bleibt Ihrer freien Wahl und Entscheidung überlassen, die geeigneten Befestigungsmittel entsprechend der von Ihnen gewählten Träger (Holzumrandung, Bausteine, Zementplatten,...) zu verwenden.



FIXING THE GREENHOUSE BASE TO THE GROUND

FIXING ON SOIL (POINT FOUNDATION)

- Position the greenhouse base in the desired location at a level position.
- Locate the base legs as shown bellow.
- Mark a 300 x 300 mm square around the base legs and dig 450 mm deep.
- Place the greenhouse base, level it and fill the holes with concrete.

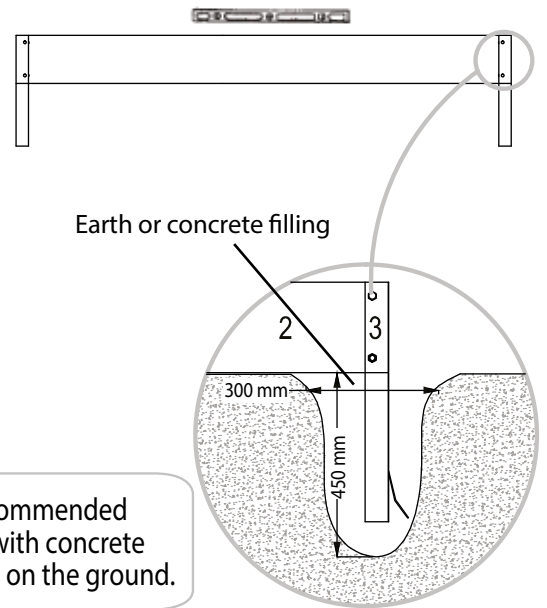
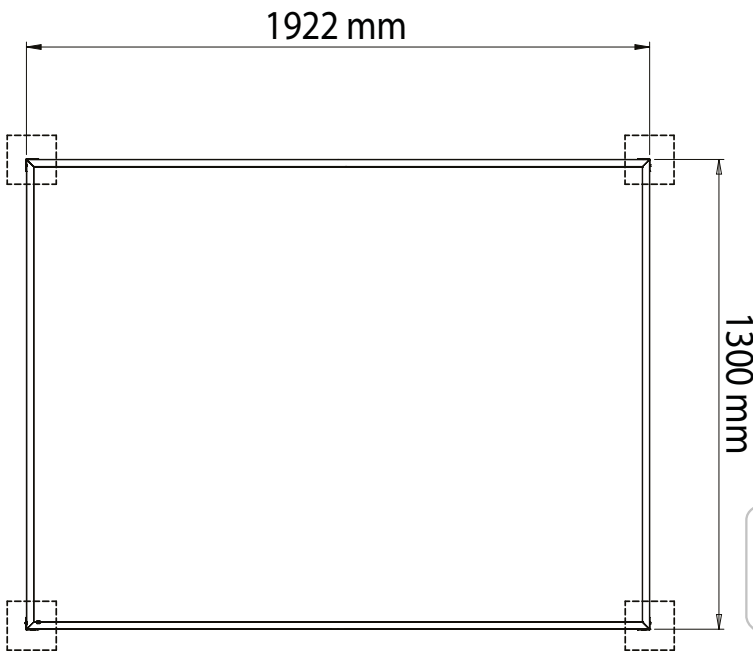

It is strongly recommended to fill the holes with concrete for a better hold on the ground.

OR

FIXING ON CONCRETE SLAB

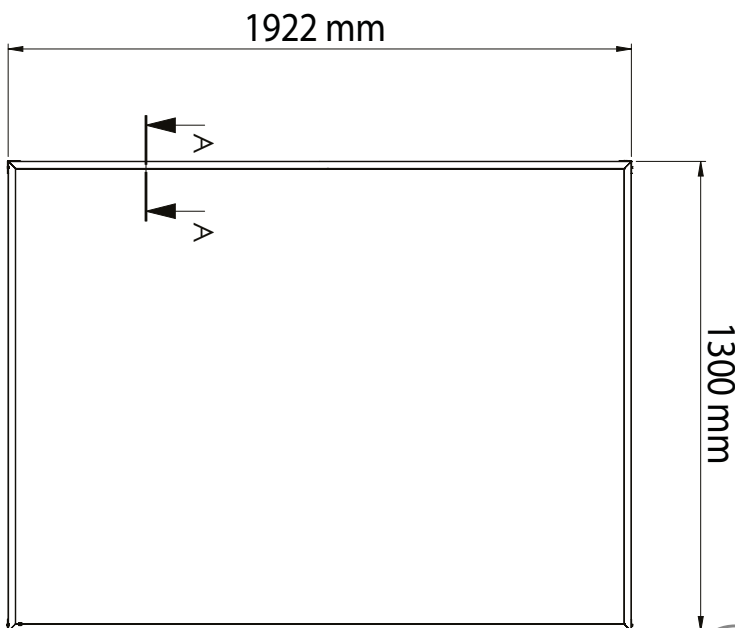

Detail A-A

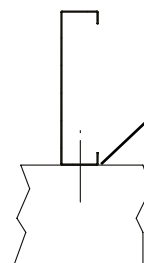

Rawplug fastening inside the greenhouse base



Screws and rawplugs not provided

It remains to your free choice and decision to use the suitable fastening means according to the supports you chose (wood border, building stones, cement plates etc.)

VIS 1002 & 1003 - SCHRAUBEN 1002 & 1003 - SCREWS 1002 & 1003

Mise en place des vis 1002 et 1003 dans les rainures en forme de T des profilés aluminium :
Entrez la tête de vis dans la rainure du profilé et tournez à 90° afin qu'elle ne puisse pas sortir du profilé. Assemblez la/les pièce(s) nécessaire(s) et serrez l'écrou.

Verwendung der Schrauben 1002 und 1003 in den t-förmigen Nuten der Aluminiumprofile :
Schraubenkopf in die Profilnut stecken und diesen um 90° drehen, damit er nicht aus dem Profil herauskommt. Bauen Sie das/die benötigte(n) Einzelteil(e) zusammen und ziehen Sie die Schraubenmuttern an.

Principle of use of screws 1002 and 1003 in the T-shaped grooves of the aluminium profiles :
Enter the screw head into the groove of the profile and turn the screw head at 90° so that it cannot exit the profile. Assemble the required part(s) and tighten the screw nut.

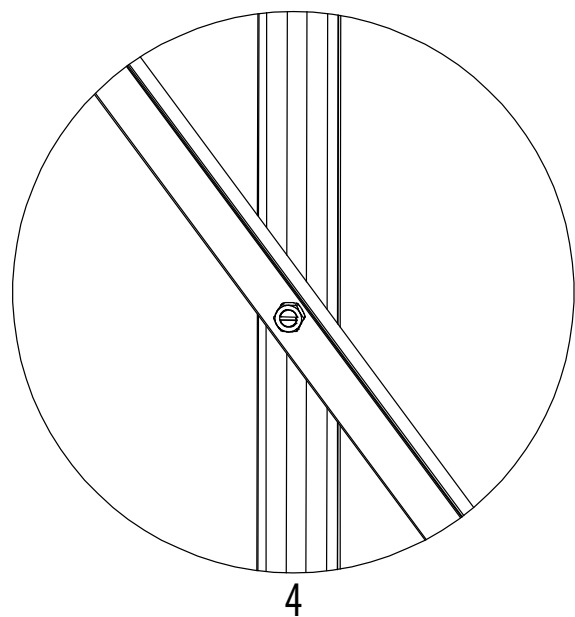
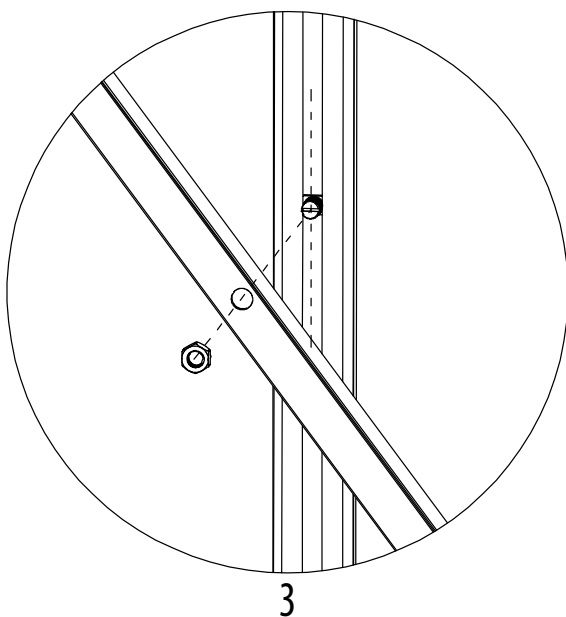
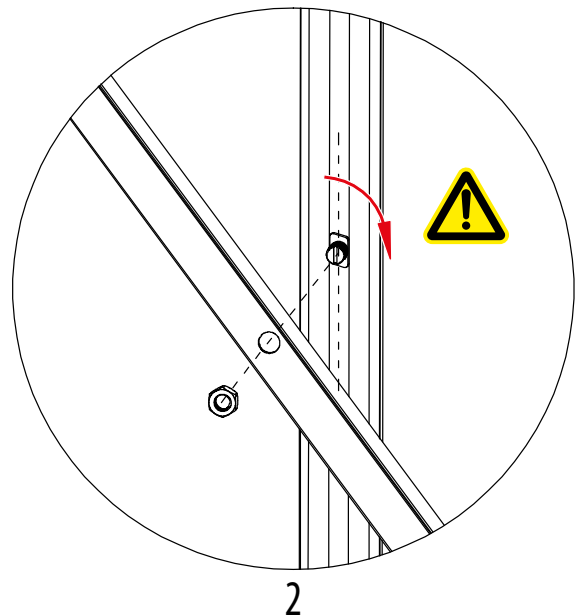
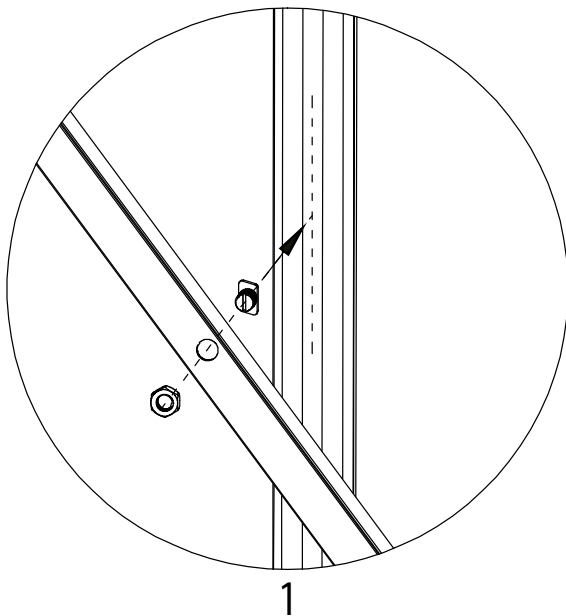

LONG-PAN (CÔTÉ) x2 - SEITENWAND x2 - SIDE WALL x2



Fixation des profilés de vitrage sur la traverse haute.
 Befestigung der Verglasungsprofile am oberen Querträger.
 Fastening the glazing profiles on the upper crossbeam.

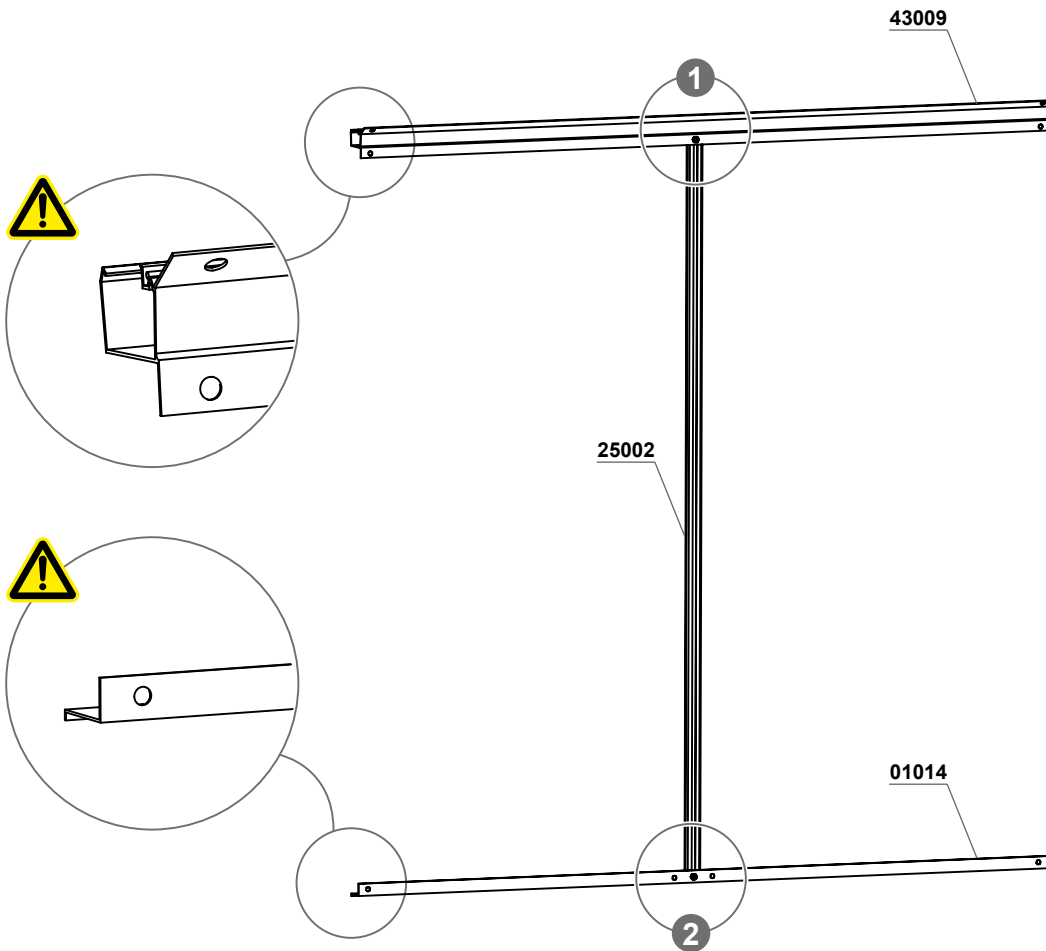

Module de base
 Basismodul
 Basic module

	01014 x 2
	25002 x 2
	43009 x 2
	1001 x 4
	1002 x 4

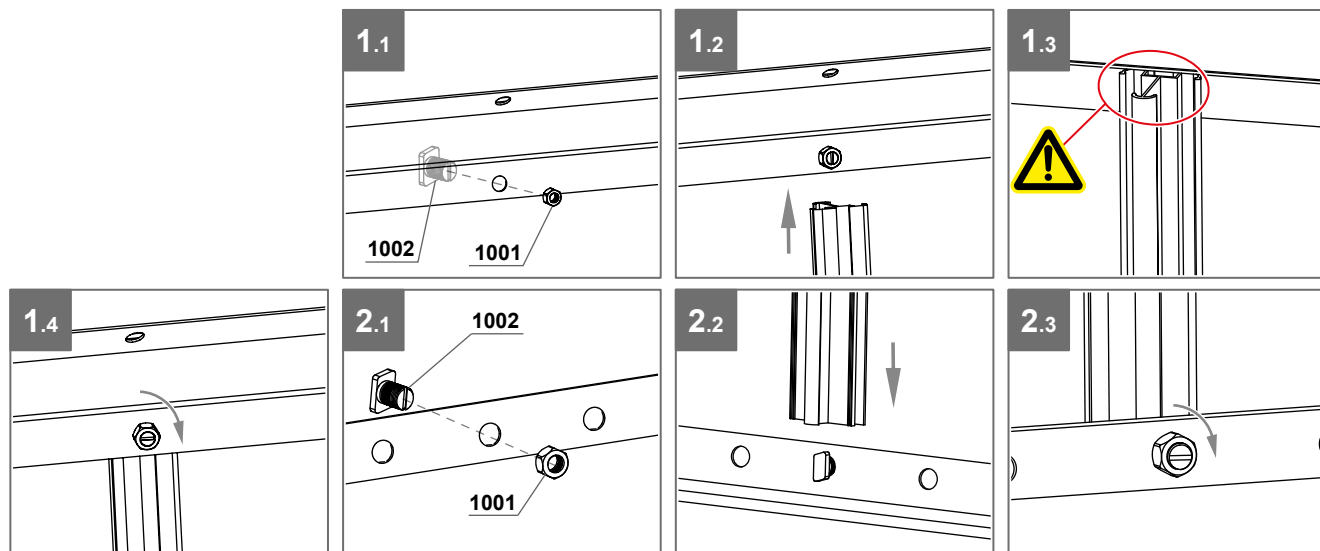

FACE AVANT (AVEC PORTE) - VORDERWAND (MIT TÜR) FRONT WALL (WITH DOOR)

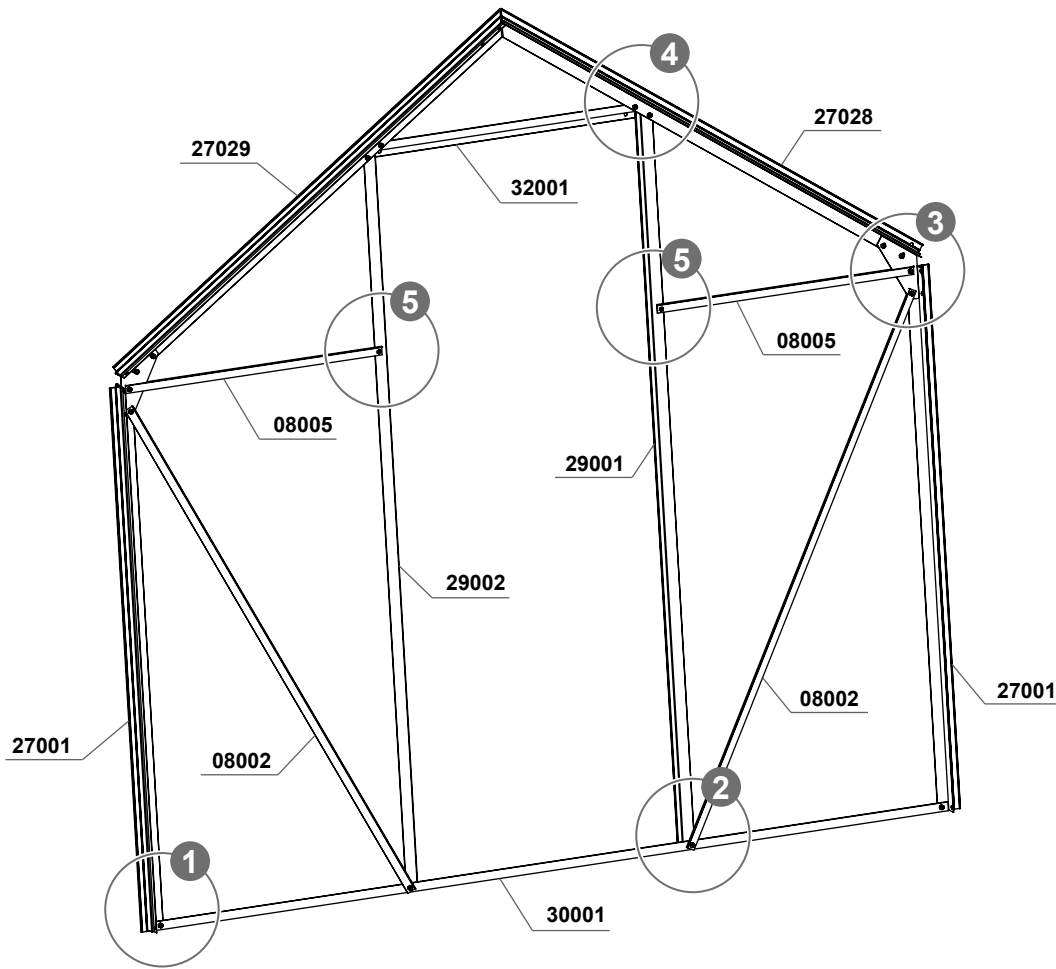

Vue intérieure
Innenansicht - Interior view



Vue intérieure
Innenansicht - Interior view

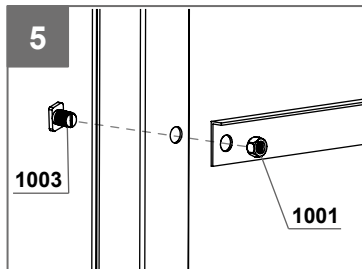
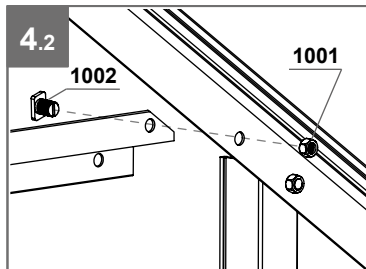
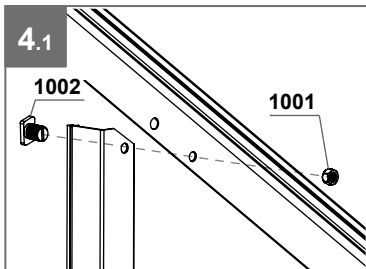
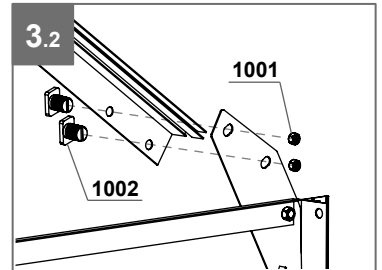
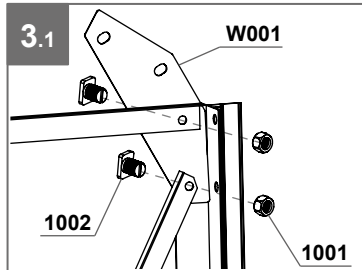
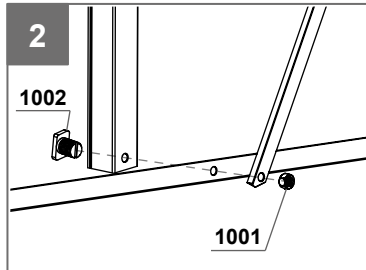
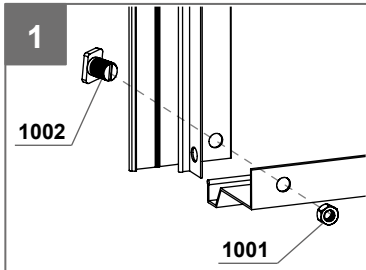

Module de base Basismodul Basic module

27028 x 1	27029 x 1	29001 x 1	29002 x 1	30001 x 1	32001 x 1	W001 x 2	1001 x 18	1002 x 16	1003 x 2

27001 x 2	08002 x 2	08005 x 2

FACE ARRIÈRE (SANS PORTE) - RÜCKWAND (OHNE TÜR) REAR WALL (WITHOUT DOOR)

Module de base
Basismodul
Basic module

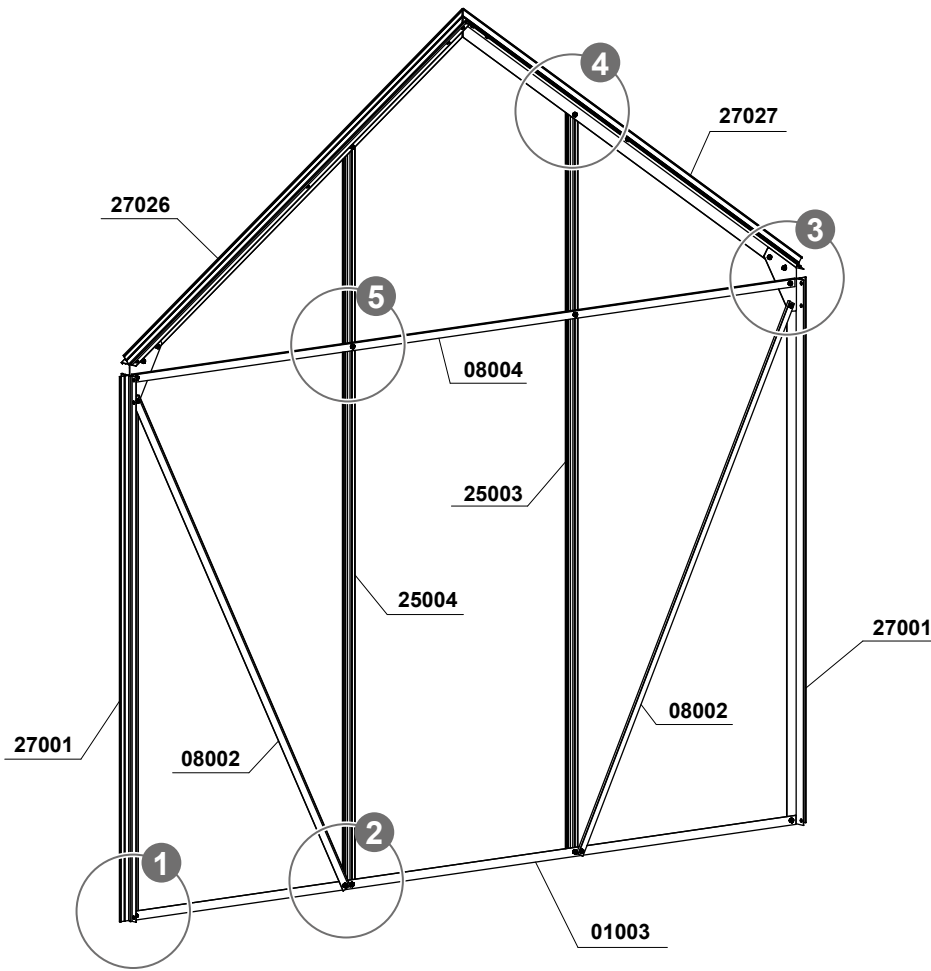

Vue extérieure
Außenansicht
Exterior view



Vue intérieure
Innenansicht
Interior view



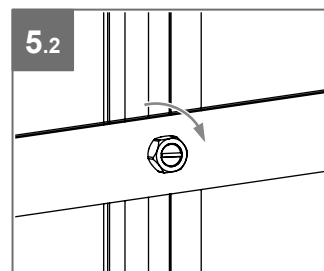
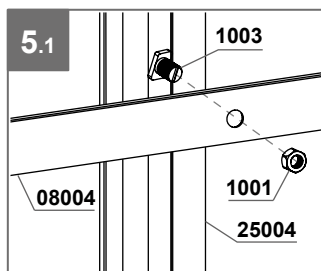
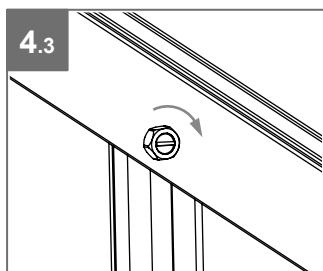
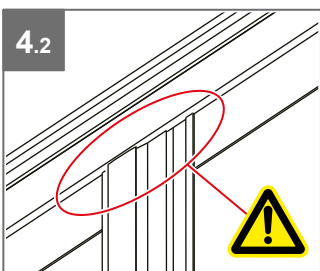
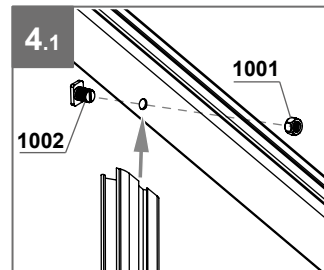
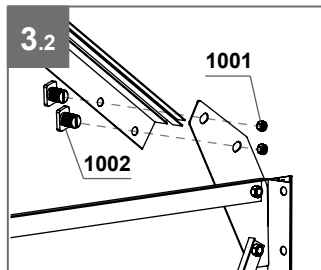
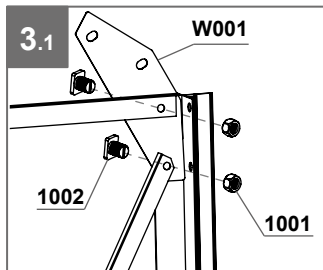
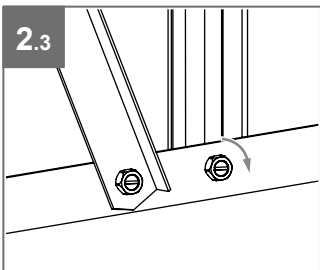
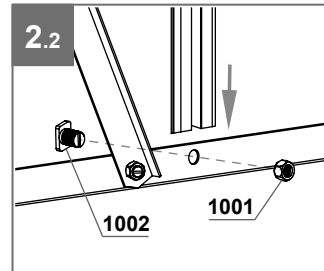
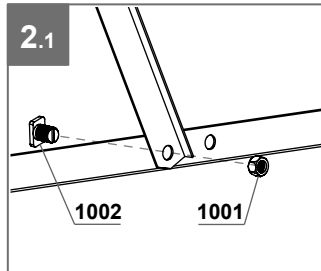
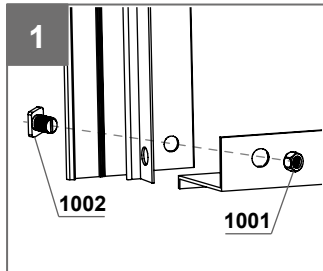



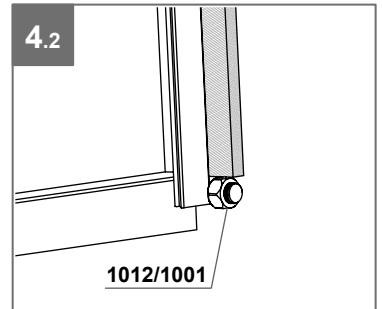
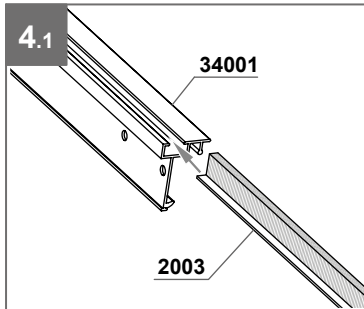
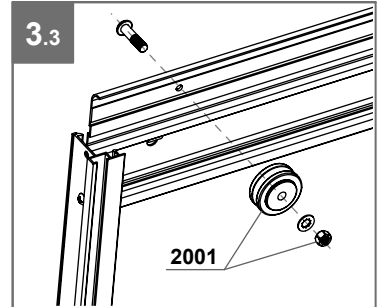
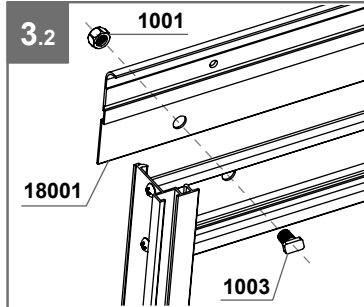
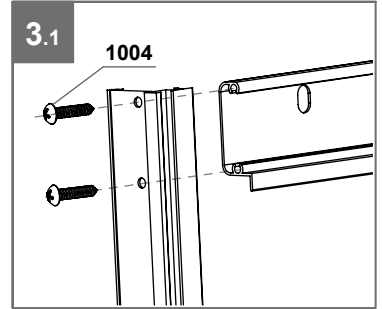
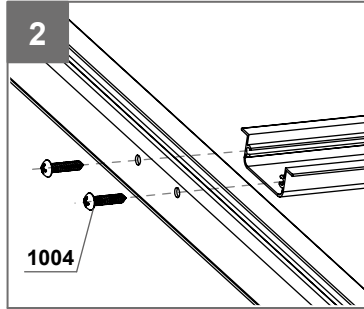
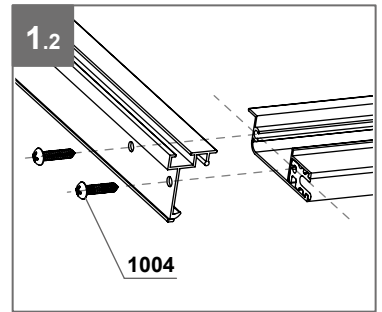
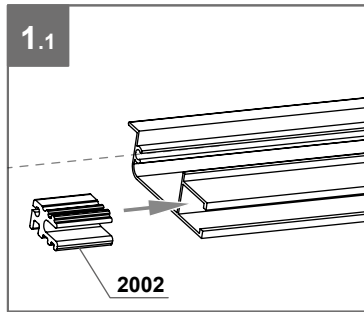
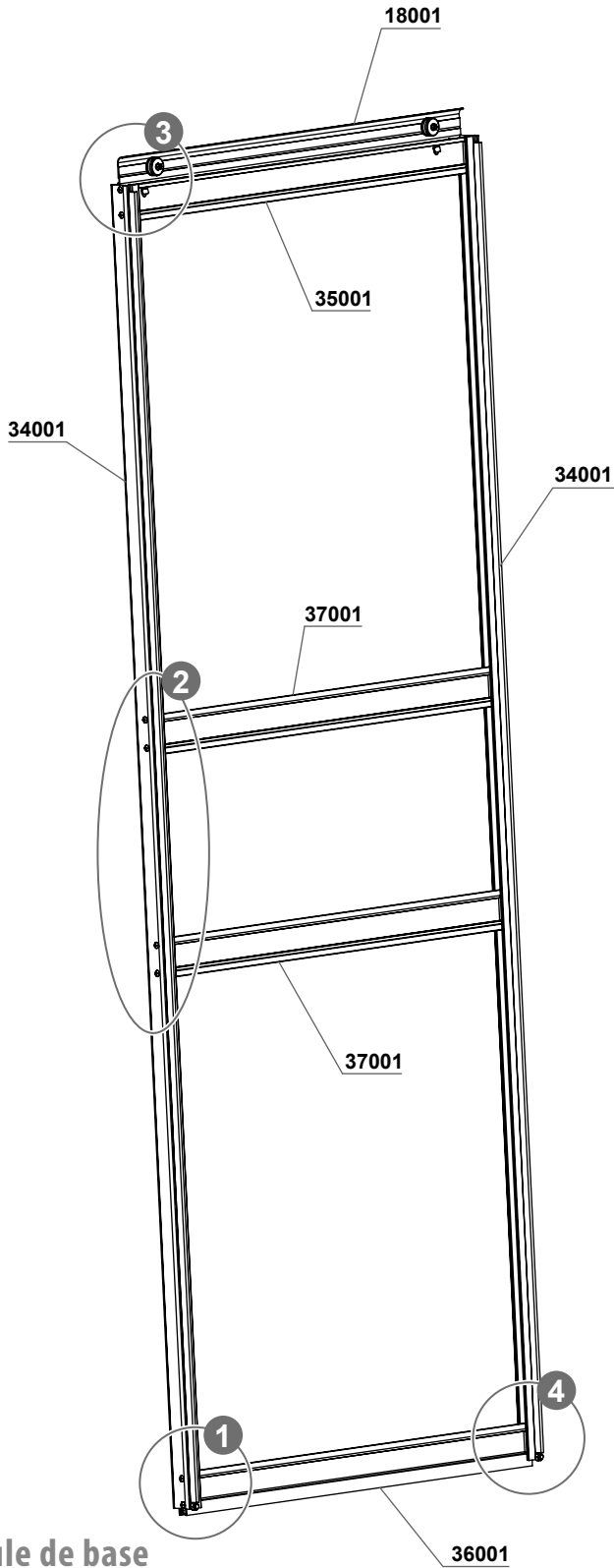

	01003 x 1
	08002 x 2
	08004 x 1
	25003 x 1
	25004 x 1
	27001 x 2
	27026 x 1
	27027 x 1
	W001 x 2
	1001 x 18
	1002 x 16
	1003 x 2



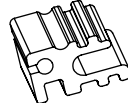

PORTE - TÜR - DOOR

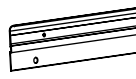

Module de base
Basismodul
Basic module

								
36001 x 1	37001 x 2	2001 x 2	2002 x 2	2003 x 2	1001 x 4	1003 x 2	1004 x 16	1012 x 2

		
18001 x 1	34001 x 2	35001 x 1

LUCARNE - FENSTER - WINDOW

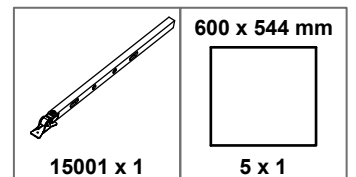
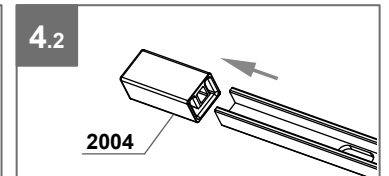
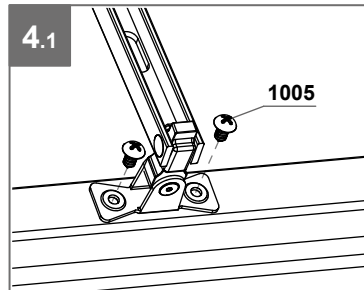
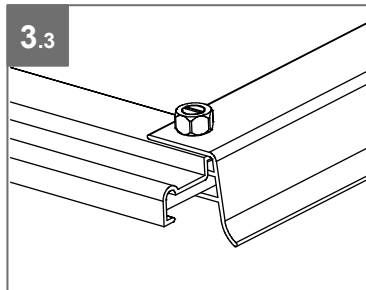
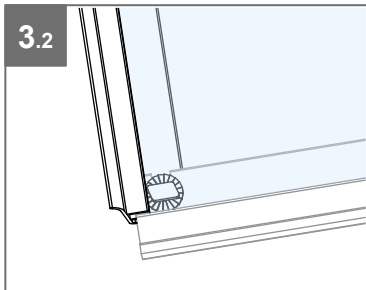
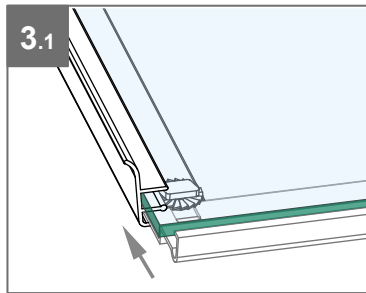
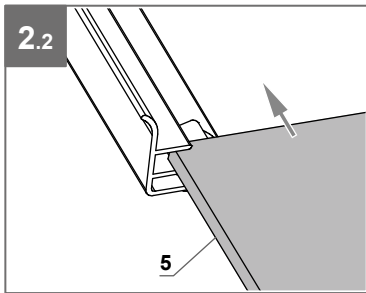
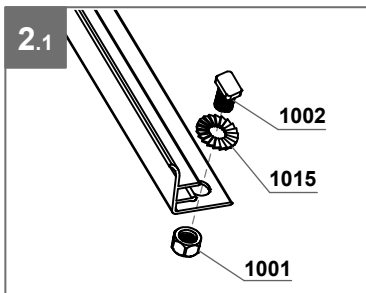
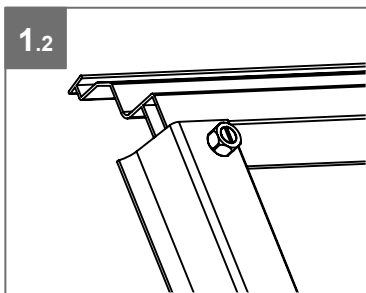
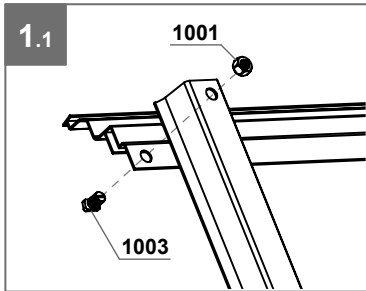
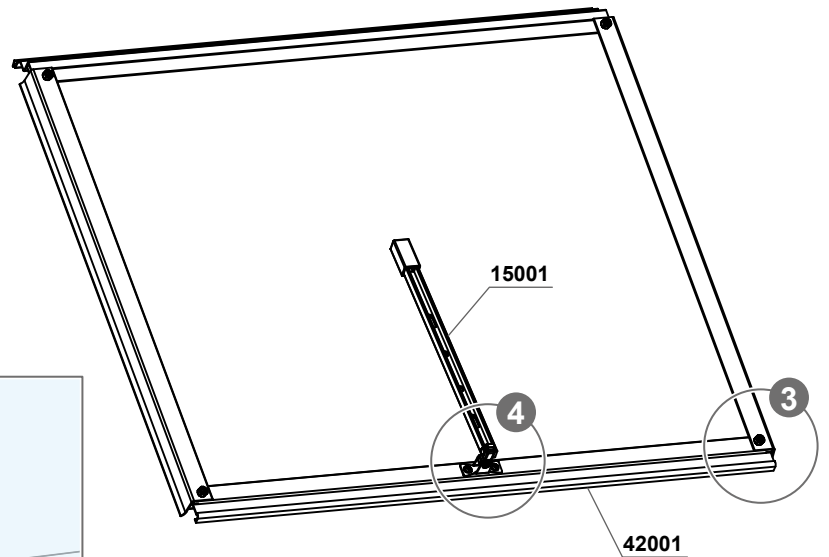
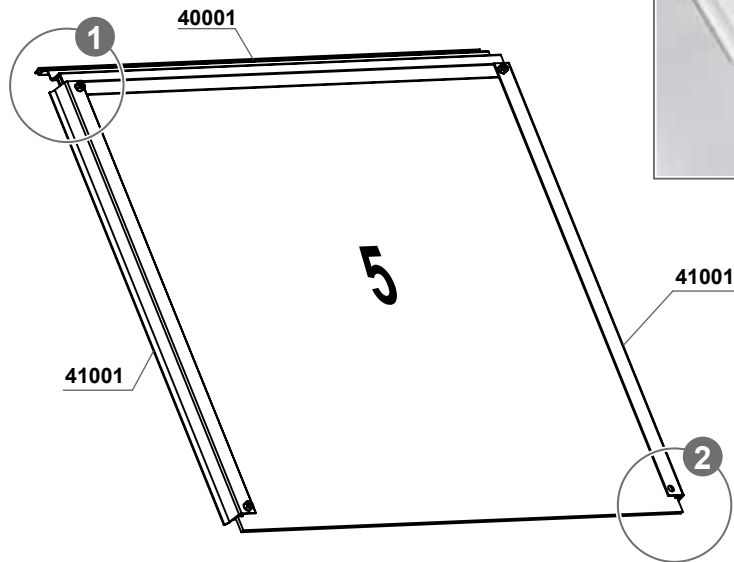

Module de base - Basismodul - Basic module

40001 x 1	41001 x 2	42001 x 1	2004 x 1	1001 x 4	1002 x 2	1003 x 2	1005 x 2	1015 x 2

ASSEMBLAGE DES PAROIS - ZUSAMMENBAU DER WÄNDE

ASSEMBLY OF THE WALLS

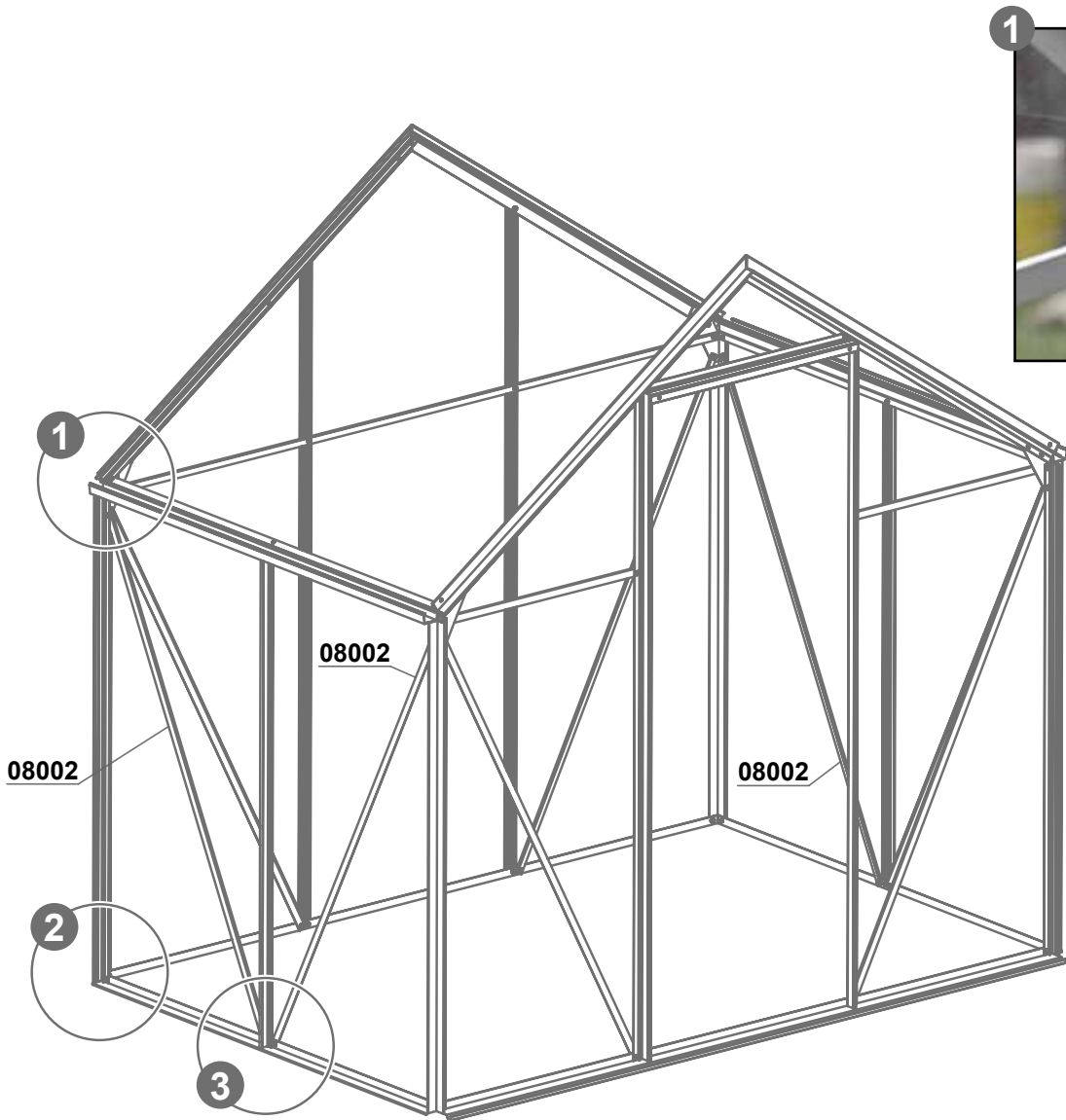

Module de base
Basismodul
Basic module

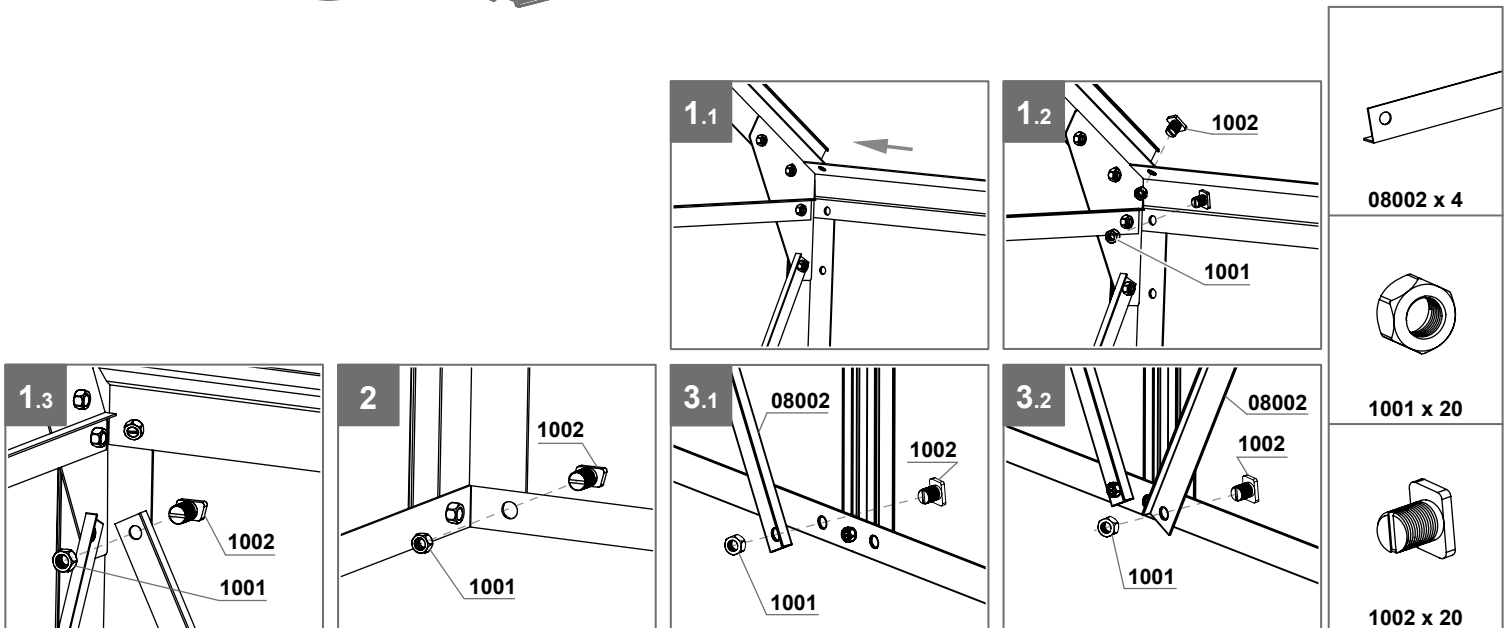

MONTAGE DES PROFILÉS DE TOITURE - MONTAGE DER DACHPROFILE ASSEMBLING THE ROOF PROFILES

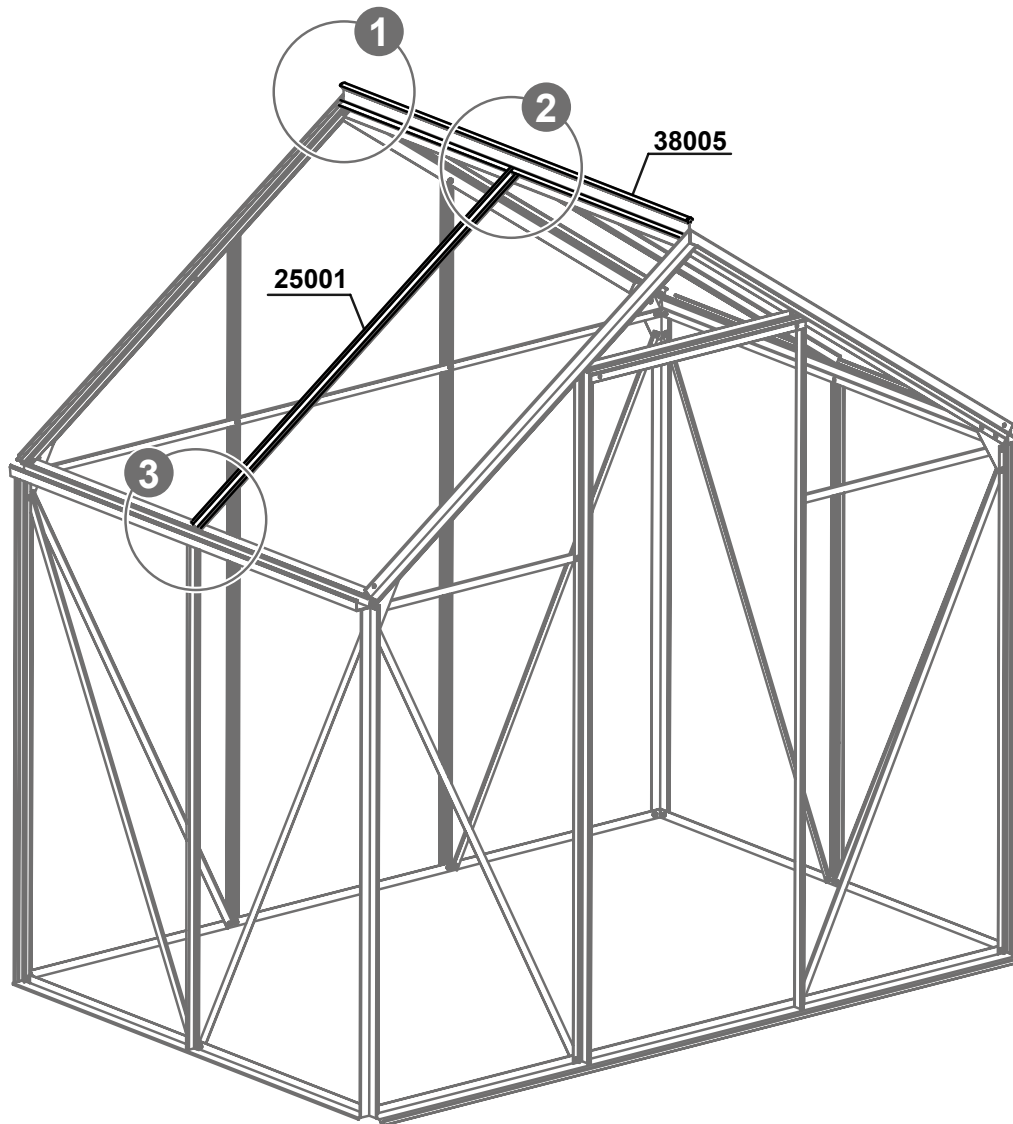

Module de base
Basismodul
Basic module

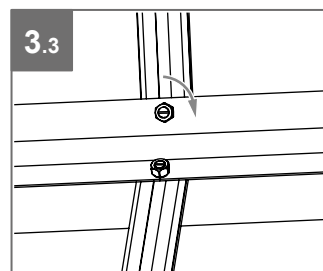
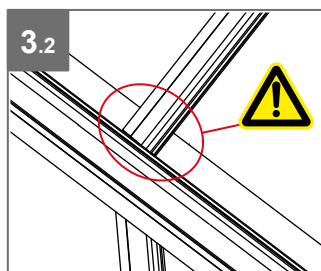
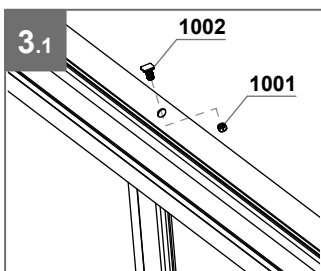
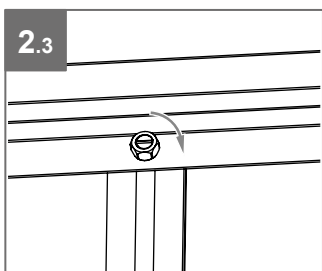
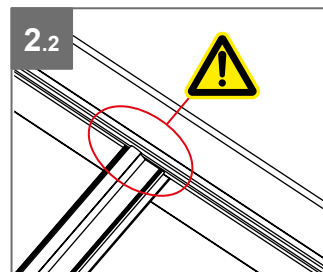
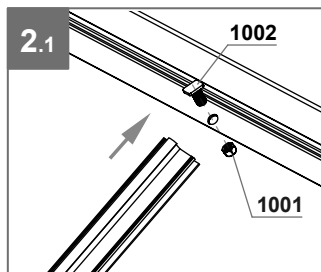
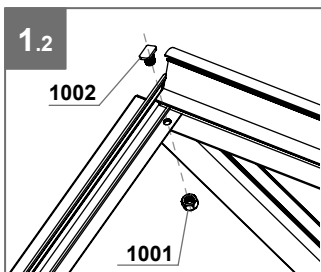
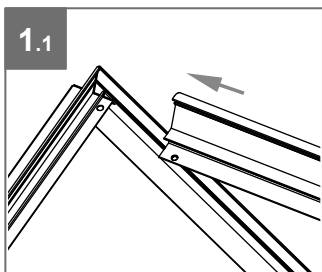
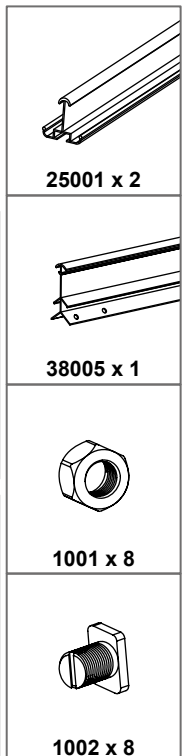

FIXATION DE LA SERRE SUR LA BASE

BEFESTIGUNG DES GEWÄCHSHAUSES AM FUNDAMENTRAHMEN

FASTENING THE GREENHOUSE ONTO THE GREENHOUSE BASE

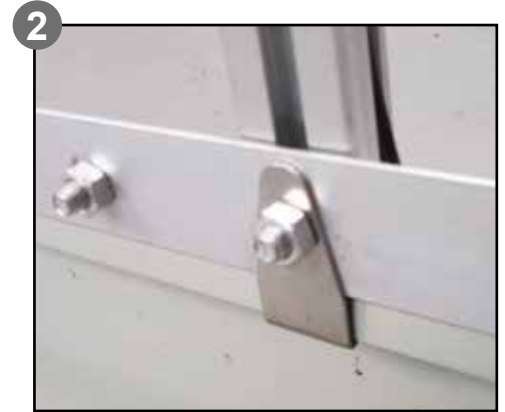
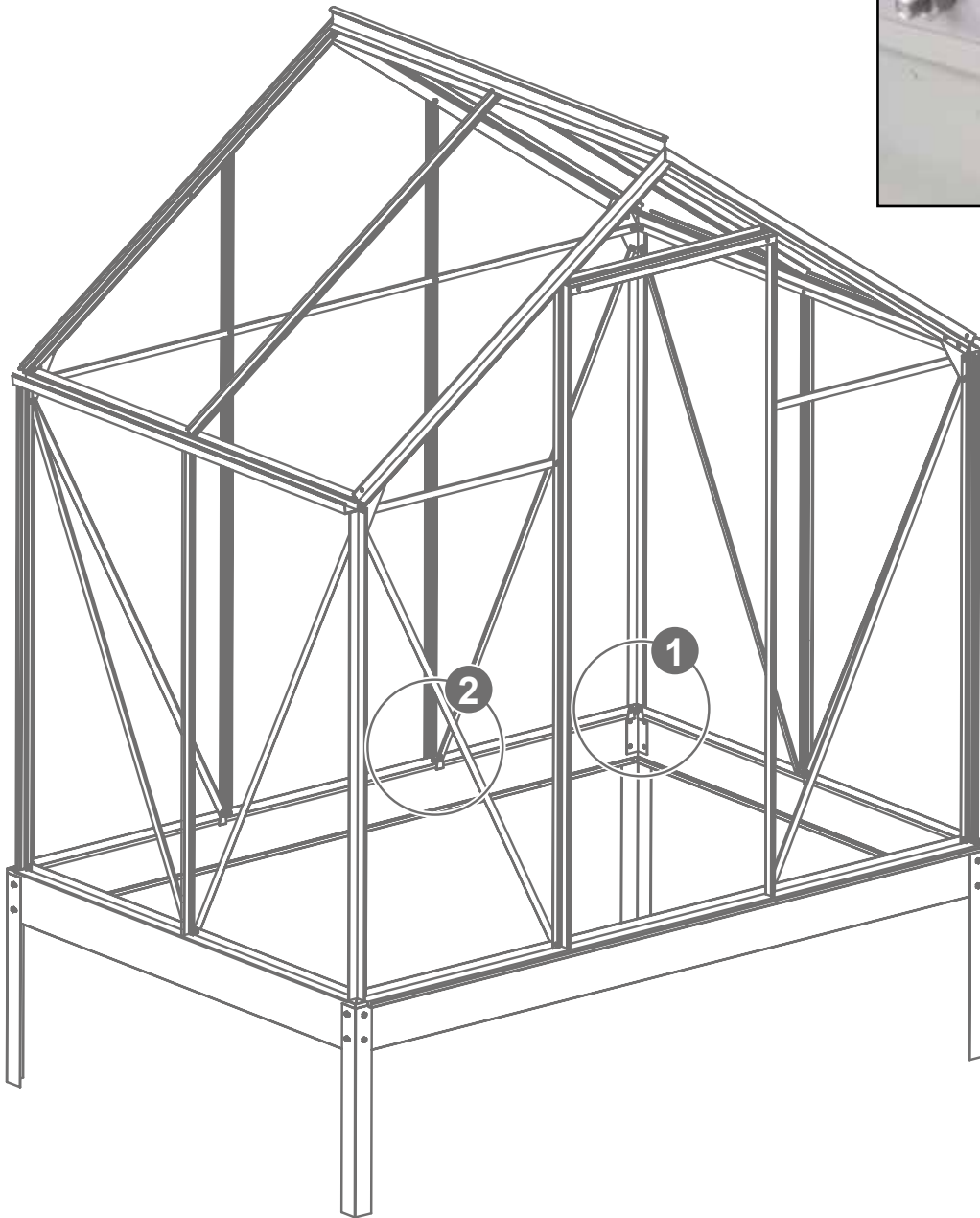

Crochet à positionner
Haken anbringen
Attach hook

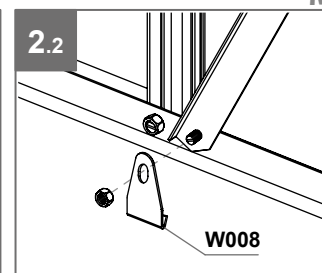
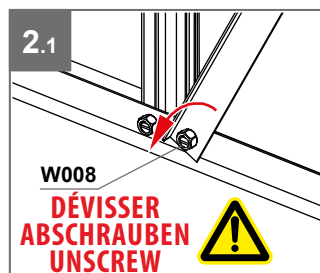
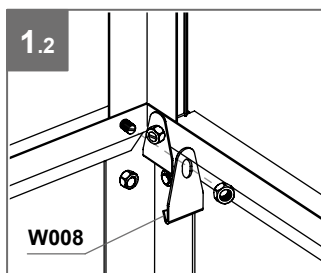
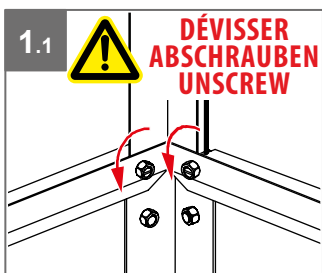

Module de base
Basismodul
Basic module

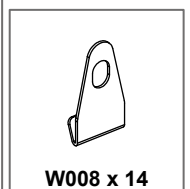

MONTAGE PORTE + RAIL MONTAGE TÜR + SCHIENE ASSEMBLING DOOR + RAIL

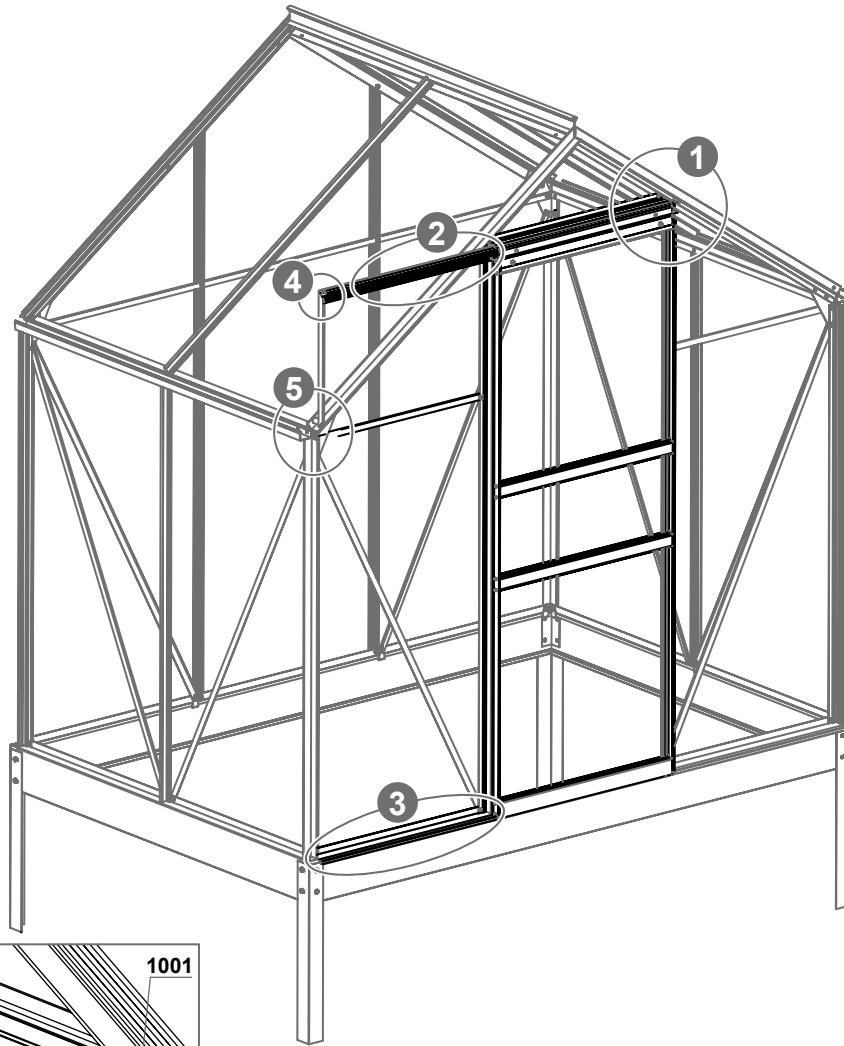

Recommandation : graissage régulier
Empfehlung : regelmäßig schmieren
Recommendation : grease regularly

Module de base
Basismodul
Basic module

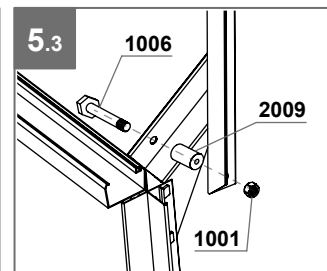
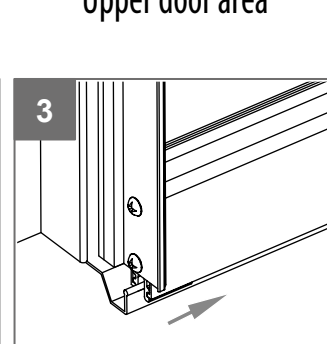
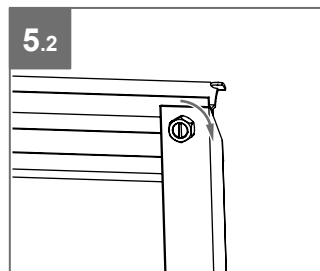
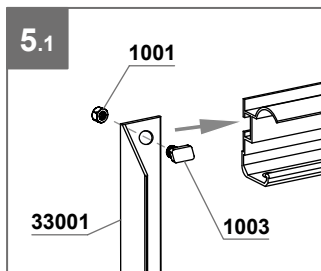
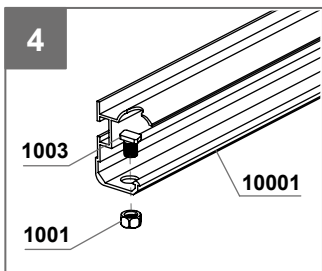
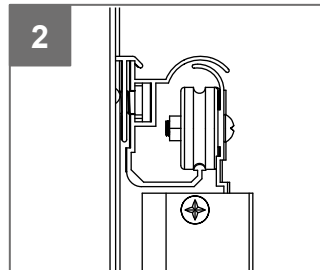
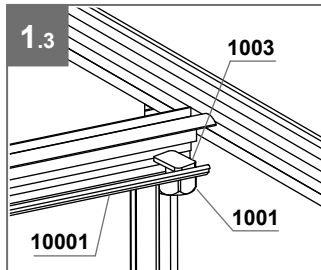
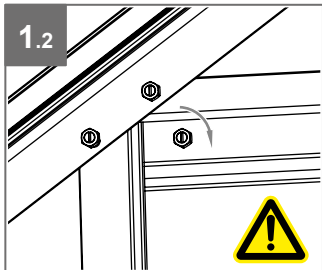
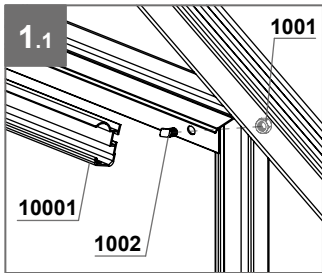

Haut de porte
Oberer Türbereich
Upper door area

	10001 x 1
	33001 x 1
	2009 x 1
	1001 x 6
	1002 x 2
	1003 x 3
	1006 x 1

POSE DU JOINT DE VITRAGE

VERGLASUNGSDICHTUNG ANBRINGEN

INSTALLING THE GLAZING SEAL

Le joint caoutchouc est à poser sur les profilés verticaux de toiture, de parois et de porte.
Die Gummidichtung ist an den senkrechten Dach-, Wand- und Türprofilen anzubringen.
The rubber seal should be placed on the vertical roof, walls and door profiles.

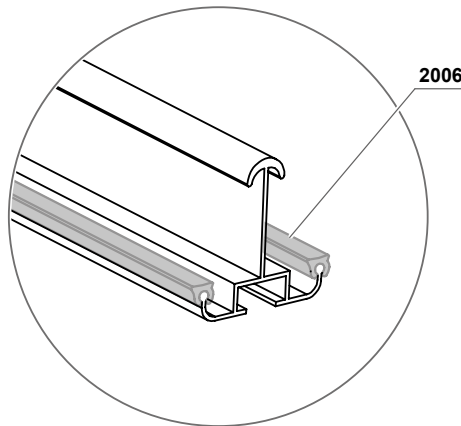

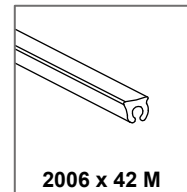

Module de base
Basismodul
Basic module





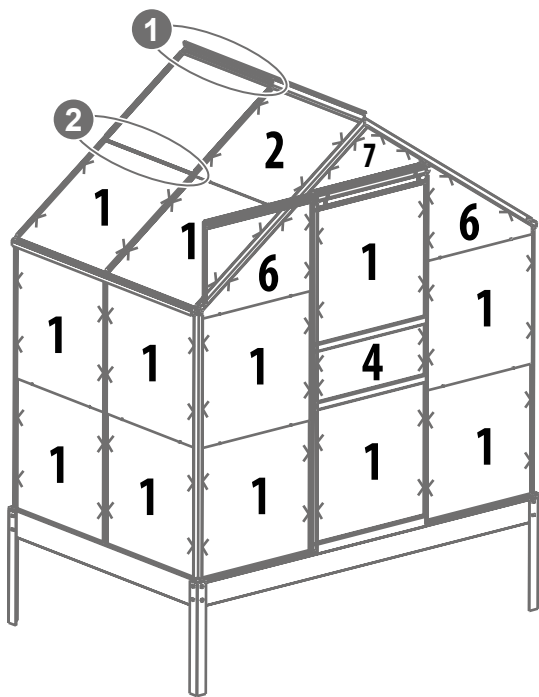





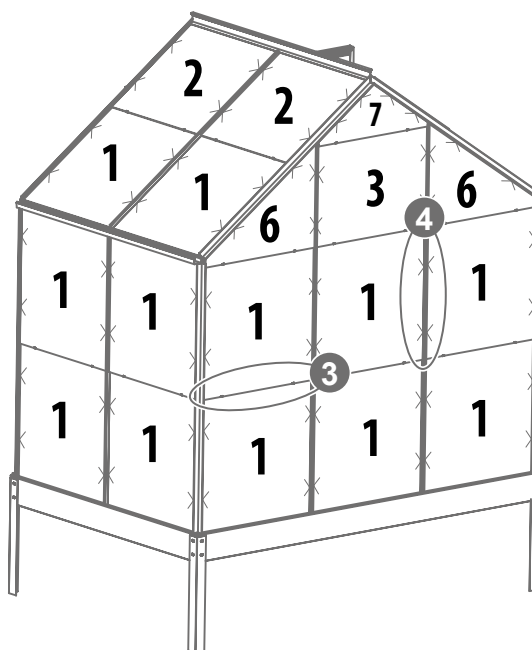





VITRAGE + POSE LUCARNE

Module de base



 Nous vous conseillons d'installer les verres niveau par niveau (du bas vers le haut).



610 x 610  1 x 24
610 x 544  2 x 3
610 x 467  3 x 1
610 x 229  4 x 1
610 x 464/38  6 x 4
610 x 20/234/20  7 x 2
 39001 x 1
 W006 x 36
 W007 x 140
 1001 x 2
 1002 x 2
 1005 x 4
 2005 x 2
 2006 x 42m



1.1 Pose de la lucarne sur faîtière par glissement



1.2 Lucarne Vue extérieure

Il peut être nécessaire de dévisser temporairement certains profilés pour la mise en place des verres. Resserrer correctement les vis après la pose des verres.

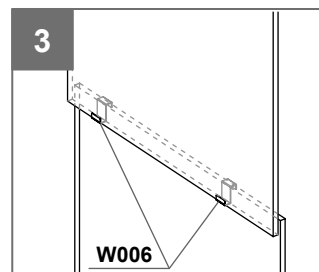
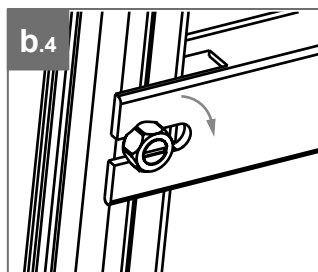
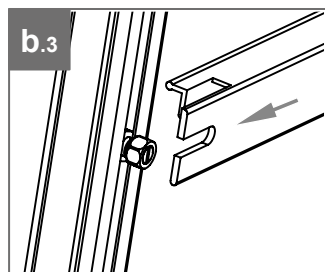
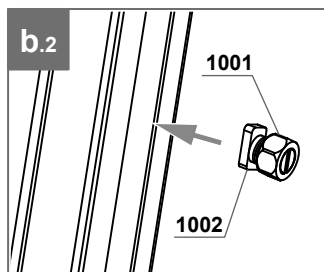
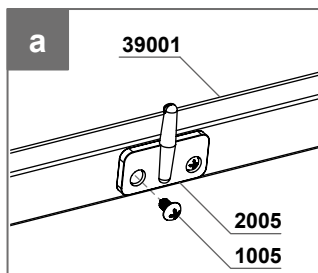
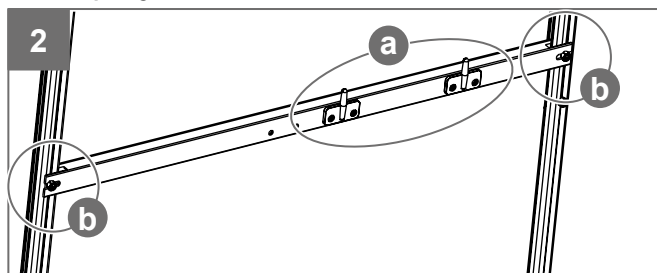

Crochets de vitrage

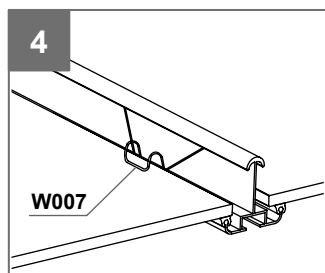

Clips de vitrage



VERGLASUNG + FENSTER EINBAUEN

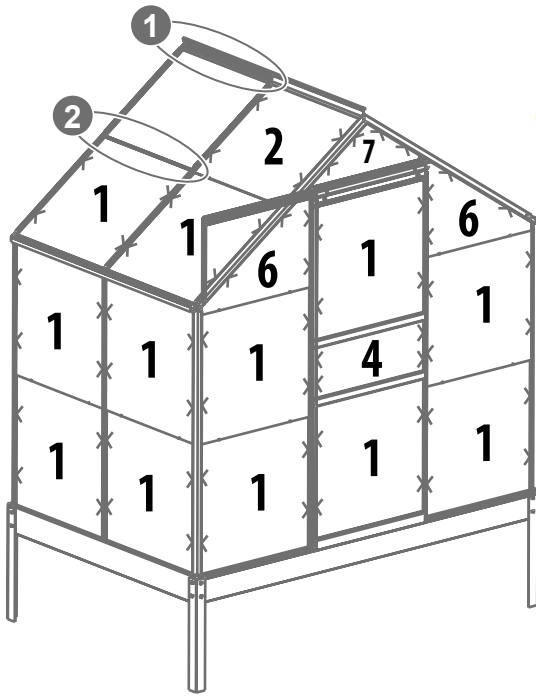

Wir empfehlen Ihnen, die Gläser Ebene für Ebene anzubringen (von unten nach oben).

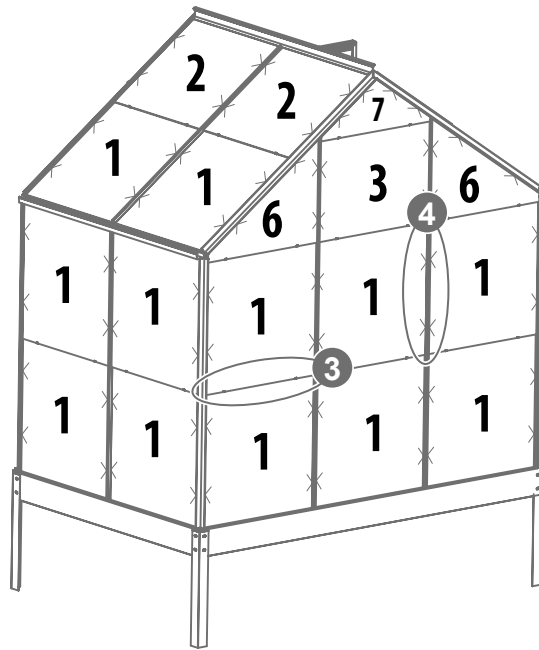

Basismodul

610 x 610



1 x 24

610 x 544

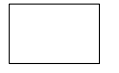

2 x 3

610 x 467

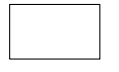

3 x 1

610 x 229

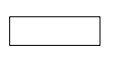

4 x 1

610 x 464/38

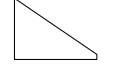

6 x 4

610 x 20/234/20

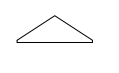

7 x 2

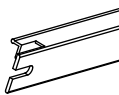

39001 x 1

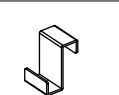

W006 x 36



W007 x 140

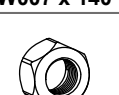

1001 x 2

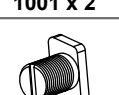

1002 x 2



1005 x 4

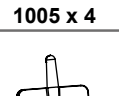

2005 x 2



2006 x 42m



1.1 Anbringung des Fensters auf First durch Gleiten



1.2 Fenster Außenansicht

Zum Anbringen der Gläser kann es erforderlich sein, bestimmte Profile vorübergehend abzuschrauben. Schrauben Sie diese nach der Anbringung der Gläser wieder fest.

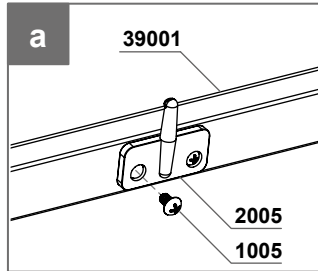
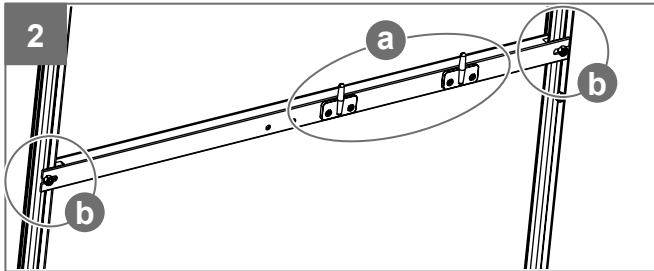

b.1 Dichtung schneiden um Einzelteil 39001 durchzulassen

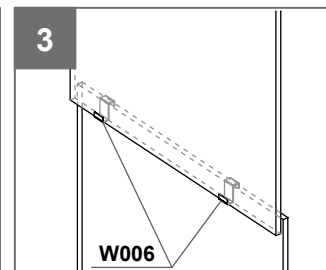
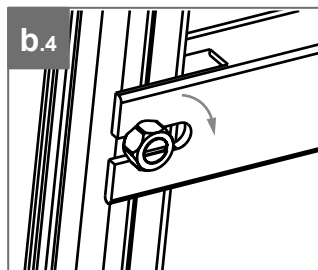
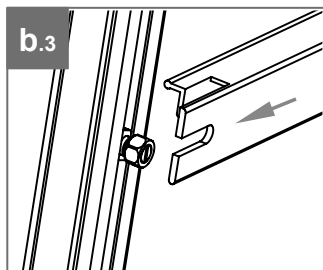
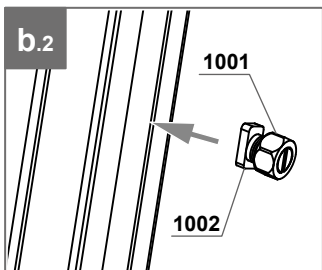

Verglasungshaken

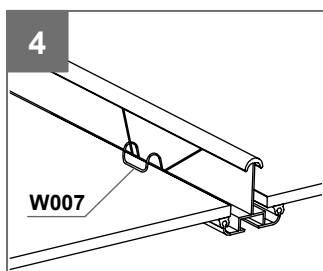

Gewächshausklammern



GLAZING + INSTALLING WINDOW

Basic module

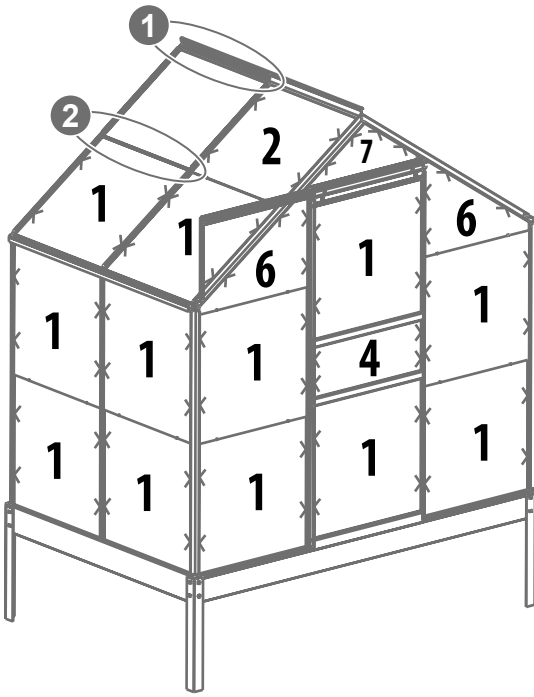

We advise you to install the glazing level by level (from bottom to top).

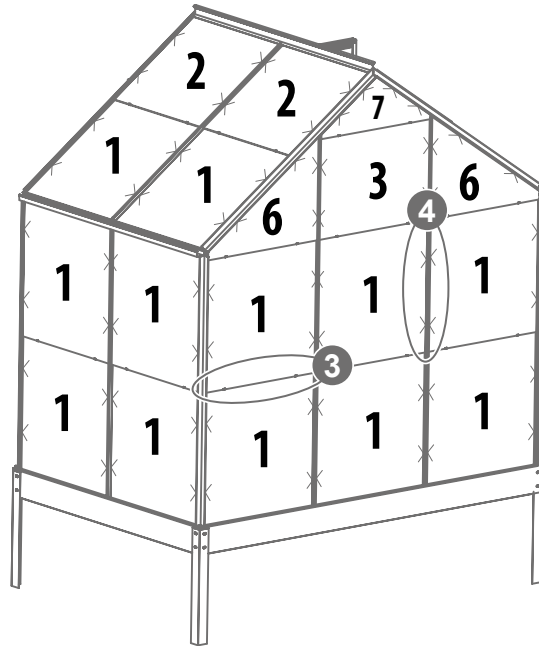

610 x 610



1 x 24

610 x 544



2 x 3

610 x 467



3 x 1

610 x 229

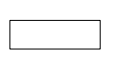

4 x 1

610 x 464/38

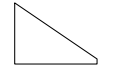

6 x 4

610 x 20/234/20

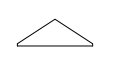

7 x 2



39001 x 1

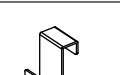

W006 x 36



W007 x 140



1001 x 2

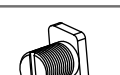

1002 x 2



1005 x 4

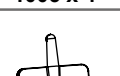

2005 x 2



2006 x 42m



1.1

Installing the window on roof ridge through sliding



1.2

Window Exterior view

Some profiles may need to be temporarily unscrewed to install the glazing. Refix the screws correctly after installing the glazing.

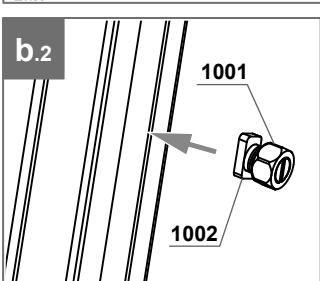
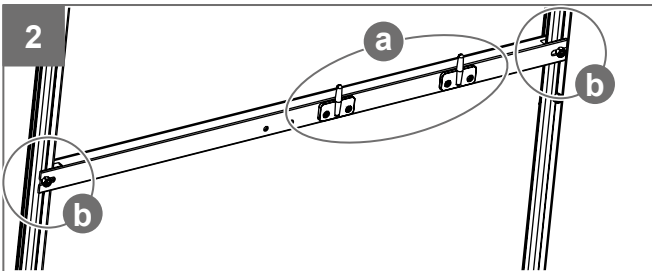

Glazing hooks

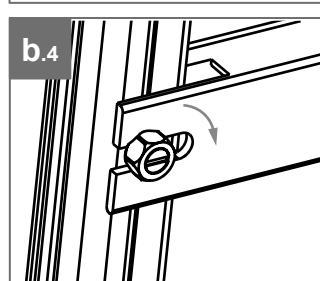
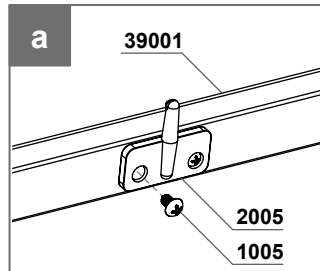
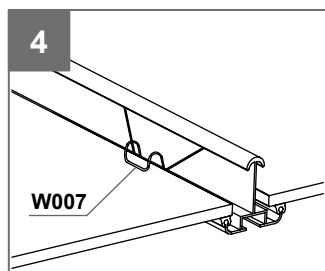
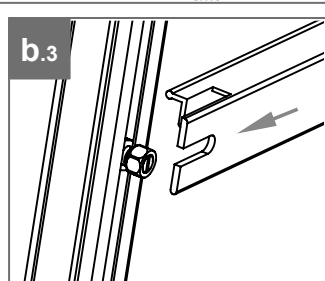

Cut the seal to let part 39001 through

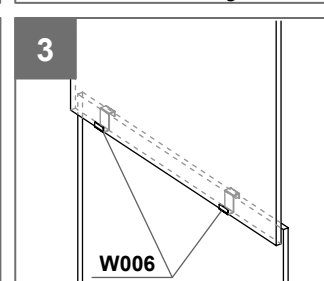

Glazing clips

MONTAGE DES PIÈCES PLASTIQUES

MONTAGE DER KUNSTOFFTEILE

ASSEMBLY PLASTIC PARTS

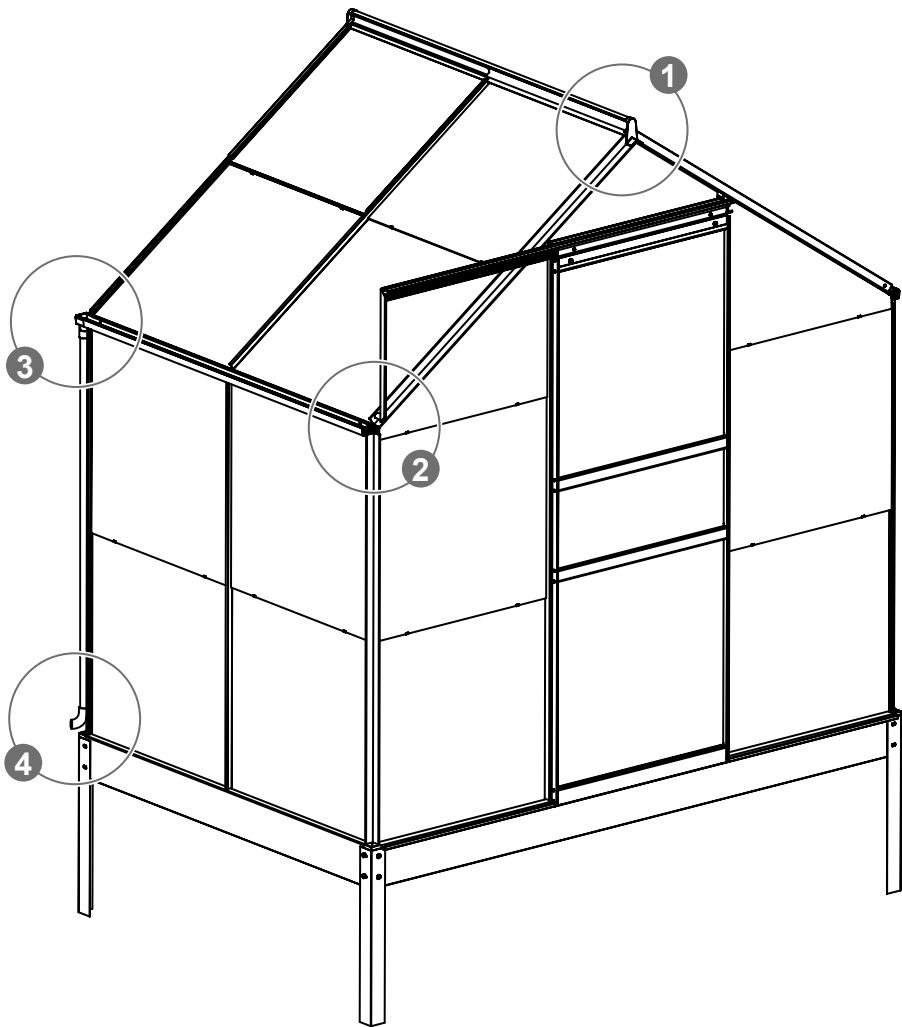

Détail embout de faitière (pièce 2010)
 Abdeckung der Firstspitze (Einzelteil 2010)
 Roof ridge end cover (part 2010)

Module de base Basismodul Basic module



1005 x 4



2010 x 2

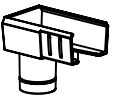

2022 x 2



2023 x 2



2028 x 2



2032 x 2

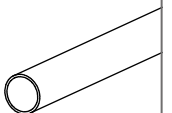

2041 x 2



58001 x 4

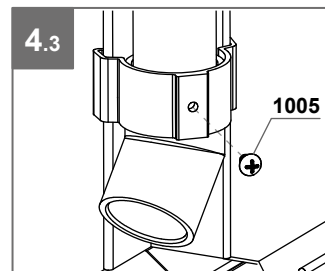
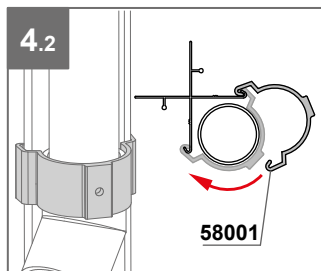
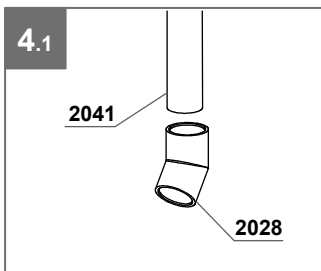
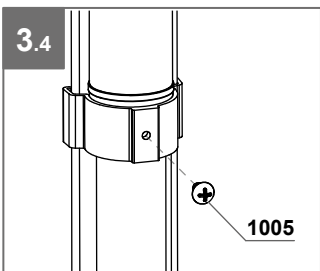
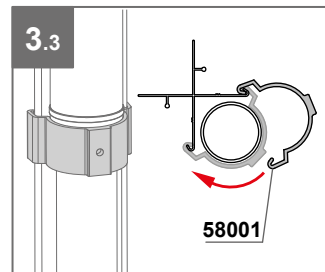
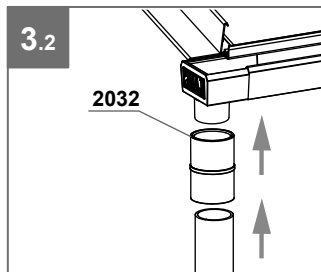
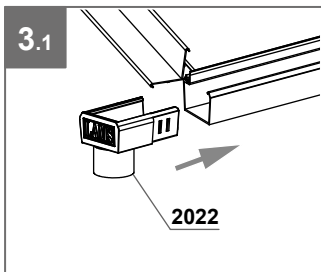
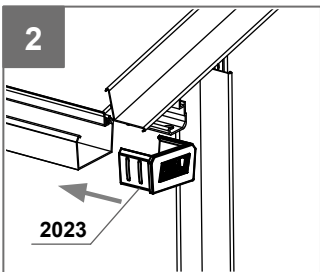
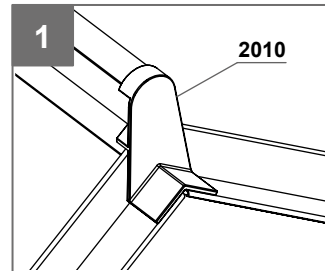

ACCESSOIRES COMPLÉMENTAIRES DISPONIBLES SUR NOTRE SITE ZUSÄTZLICHES ZUBEHÖR AUF UNSERER WEBSITE VERFÜGBAR ADDITIONAL ACCESSORIES AVAILABLE ON OUR WEBSITE

 WWW.SERRES-LAMS.COM
 WWW.GEWAECHSHAUS-LAMS.COM

QUELQUES ACCESSOIRES - EINIGE ACCESSOIRES - SOME ACCESSORIES



Système d'ombrage
Beschattungssystem
Shading system

Permet de réguler la température de votre serre.
Ermöglicht die Temperatur zu regulieren.
Allows to regulate the temperature of your greenhouse.



Kit descente de gouttière
Regenfallrohr-Set
Rain gutter kit

Permet de récupérer l'eau de pluie.
Ermöglicht das Auffangen von Regenwasser.
Allows to collect rainwater.



Ouverture automatique de lucarne
Automatischer Fensteröffner
Automatic window opener

Système d'aération automatique (à partir de 17°C).
Automatisches Belüftungssystem (ab 17°C).
Automatic aeration system (from 17°C).



Ventouse
Saugnapf
Suction cup

Facilite le transport et la pose des verres.
Erleichtert das Tragen und Anbringen der Gläser.
Facilitates the transport and installation of the glass.



Clips de vitrage à ressort
Federbelastete Gewächshausklammern
Spring glazing clips

Permettent de maintenir le vitrage des serres.
Halten die Verglasung der Gewächshäuser.
Maintain the glazing of the greenhouses.



Crochets de vitrage
Verglasungshaken
Glazing hooks

Permettent de faire chevaucher deux vitrages.
Ermöglicht die Überlappung von zwei Glasscheiben.
Allows the overlap of two glasses.



DOVIRIS - 43 Av. Georges Clémenceau 85120 LA CHÂTAIGNERAIE - FRANCE

 **WWW.SERRES-LAMS.COM**

SERVICE CLIENTS

Site internet : www.sav-doviris.com

 **WWW.GEWAECHSHAUS-LAMS.COM**

KUNDENSERVICE

kontakt@gewaechshaus-lams.com



FR

**DONNEZ
OU
RECYCLEZ**



ASSOCIATION

OU



MAGASIN

OU



LIVRAISON

OU



DÉCHÈTERIE



FR



Adresses sur quefairedemesdechets.fr